



70 RT HP is a new range of 16A to 160A switch disconnectors in isolating material and metal, supplied in a box. Available in control and emergency versions, the range is completed by board versions for front-panel or DIN rail assembly, in 16 to 63A options, all of which can be equipped with auxiliary contacts. These devices have been designed to deliver the ultimate in reliability, functionality and performance. They offer a technologically advanced solution that simplifies installation, reduces wiring times and ensures maximum safety and robustness, even in the most demanding conditions, thanks to the use of high-performance materials.

Version	Box	Material	Insulation
Type	For emergency	Rated current (A)	80
No. of poles	3P	Circuit breaker	Rotary isolator
IP degree	IP66/IP67/IP69	Mechanical resistance	IK08
Ambient temperature	-25 +60 °C	Lid screws (no. and type)	4 insul. a 1/4 turn
Holes entry	2 x M25/32 + 2 x M25/32	Lockable	YES (max. 3 locks in OFF)
Type of accessory	Max. 2 auxiliary contacts	Current in AC22 (415V)	80
Current in AC23 (415V)	80	Cable section	Max 25 mm <sup>2</sup>
Outer dim. LxHxD (mm)	156x200x95	Electrocod	1742

#### BEHAVIOUR WITH CHEMICAL AND ATMOSPHERIC AGENTS

Saline solution	Acids		Bases		Solvents				Mineral oil	UV rays
	Concentrated	Diluted	Concentrated	Diluted	Hexane	Benzol	Acetone	Ethyl alcohol		
Resistant	Limited resistance	Resistant	Not resistant	Limited resistance	Limited resistance	Not resistant	Not resistant	Limited resistance	Resistant	Resistant

#### DIMENSIONAL

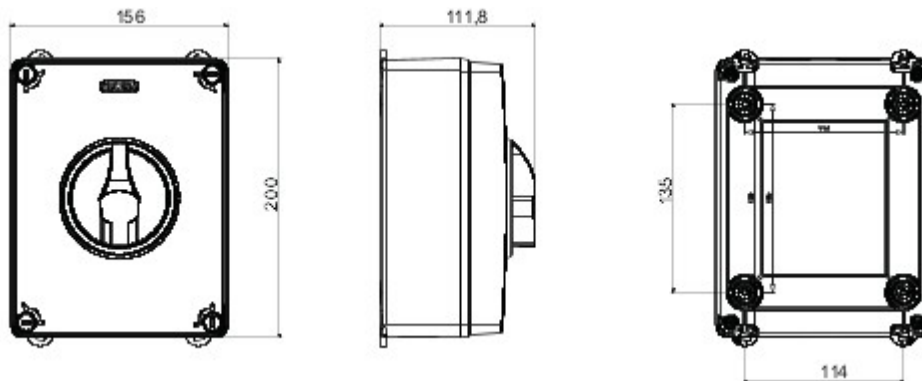

#### TECHNICAL SYMBOLOGY

**IP**

IP66/IP67/IP69

**IK**

IK08

#### STANDARDS/APPROVALS

