

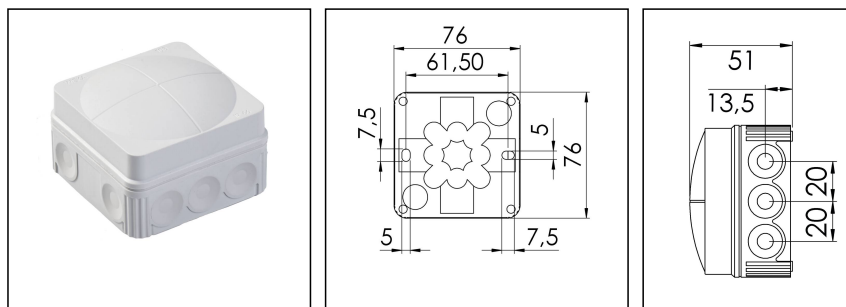

COMBI 108/5 LG

Junction box, polypropylene



Products may differ in size, colour and appearance to those shown. If you require further information or customisation, please contact us directly.



Material	Polypropylene
Material sealing gasket	TPE
Temp. range min	-30 °C
Temp. range max	100 °C
Temperatures during install.	-5 °C - 60 °C
Protection class	IP66
Glow wire test	750 °C
Voltage	400 V
Rated current / A (Terminal)	24 A
Rated cross section	2,5 mm ²
Terminals/poles	5-pole, 2,5mm ²
Fixing	2 internal openings
Ø cable diameter min	3 mm
Ø cable diameter max	14 mm
External dimensions LxWxH	76 x 76 x 51mm
Using for cable gland	
Product Color	RAL 7035
WISKA-Order no.	10060523
Type	COMBI 108/5 LG
Packing unit	10
EAN number	4007685605236
Tariff number	85369010
ETIM-Classification	EC002600

Remarks:

Your Contact:

WISKA UK Ltd.

Unit 7, Hurling Way · St. Columb Major Business Park · TR9 6SX, St. Columb Major, Cornwall · Great Britain

☎ +44-12-08816062 · 📠 +44-12-08816708

info@wiska.co.uk · www.wiska.co.uk

Equipment:

- 10 elastic self-sealing puncture-membranes for cable entry on the side and 2 in the bottom
- inclusive terminal block 5-poles, 2,5mm²

Fixing:

By two internal openings outside of the sealing area

Recommended accessories

MP-S Mounting plate small	10105774
MP-L Mounting plate large COMBI / WHK	10105775
ZER 4-12 LG	10109800
ZER 11-18 LG	10110766

Spare parts

SP-HKT 11/5 Terminal block	22001132
----------------------------	----------

18.01.2024

Your Contact:

WISKA UK Ltd.

Unit 7, Hurling Way · St. Columb Major Business Park · TR9 6SX, St. Columb Major, Cornwall · Great Britain

☎ +44-12-08816062 · 📠 +44-12-08816708

info@wiska.co.uk · www.wiska.co.uk

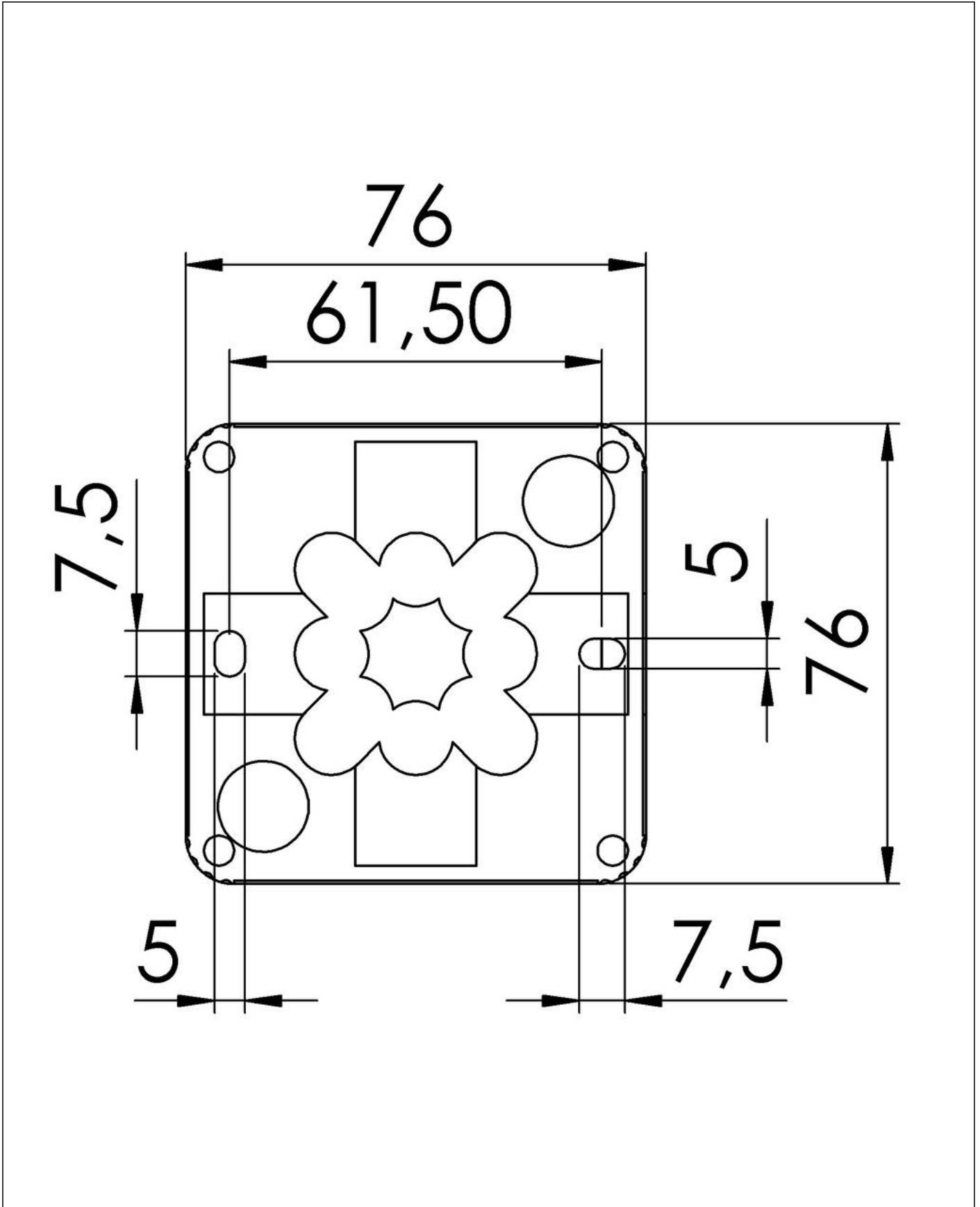

Your Contact:

WISKA UK Ltd.

Unit 7, Hurling Way · St. Columb Major Business Park · TR9 6SX, St. Columb Major, Cornwall · Great Britain

☎ +44-12-08816062 · 📠 +44-12-08816708

info@wiska.co.uk · www.wiska.co.uk

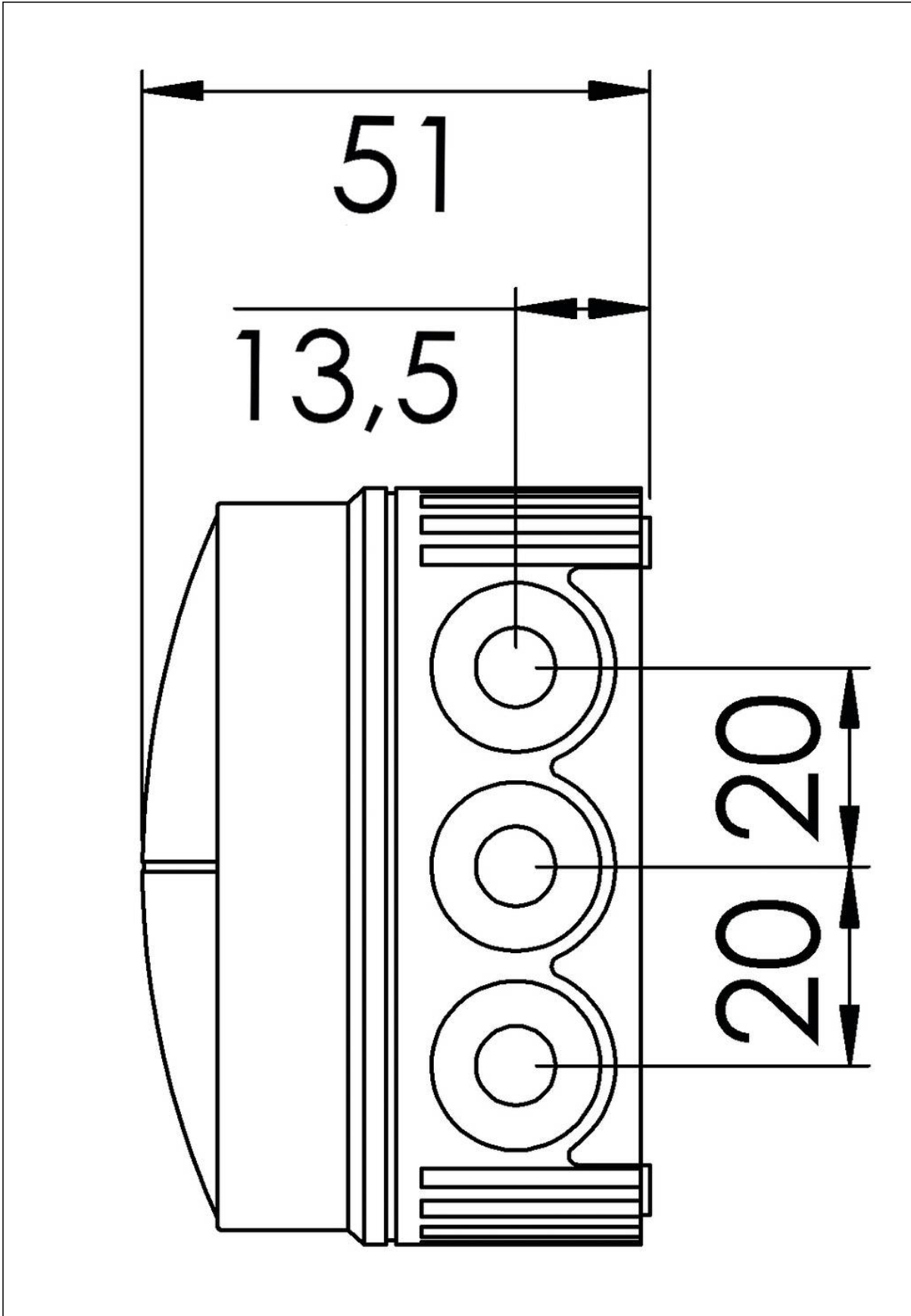

Your Contact:

WISKA UK Ltd.

Unit 7, Hurling Way · St. Columb Major Business Park · TR9 6SX, St. Columb Major, Cornwall · Great Britain

☎ +44-12-08816062 · 📠 +44-12-08816708

info@wiska.co.uk · www.wiska.co.uk