

Data sheet | Item number: 221-412

COMPACT Splicing Connector; for all conductor types; max. 4 mm²; 2-conductor; with levers; transparent housing; Surrounding air temperature: max 85°C (T85)

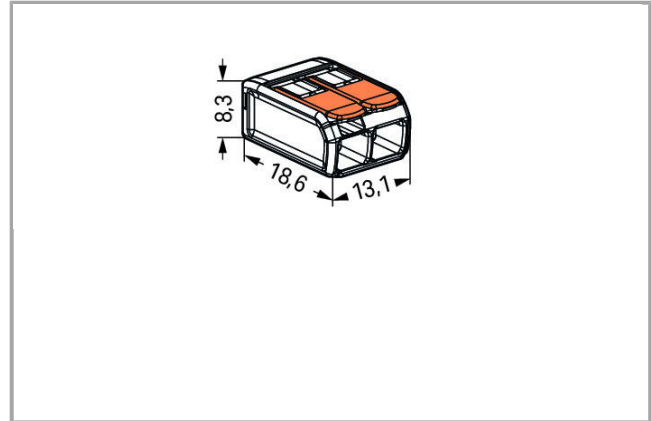

www.wago.com/221-412

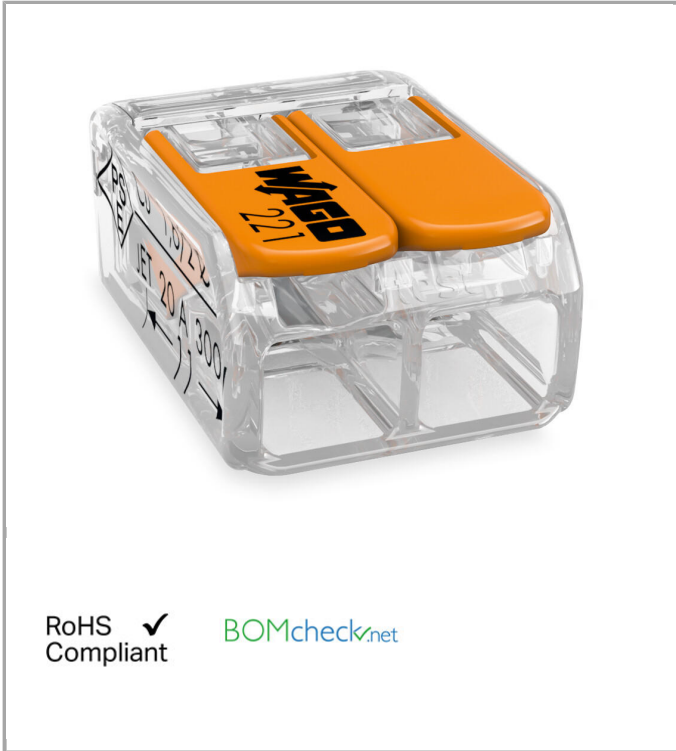

Item description

Your Benefits:

- Easy to use: Pull the lever up, insert a conductor and push the lever back down
- Available as 2-, 3- and 5-wire connectors
- Easily terminate conductors from 0.14 to 4 mm², as well as solid and stranded conductors from 0.2 to 4 mm² (24 ... 12 AWG).
- Time savings for installers and device manufacturers.



- Quickly install devices with higher levels of power consumption.
- Safely install long cable runs with larger conductor cross sections.
- Mounting carrier for installation conforming to standards
- Custom carriers are possible

Safety information 1:

In grounded power lines

Data**Electrical data****Ratings per IEC/EN 60664-1**

Rated voltage (II / 2)	450 V
Rated impulse voltage (II / 2)	4 kV
Rated current	32 A

Connection data

Connection technology	CAGE CLAMP®
Actuation type	Lever
Connectable conductor materials	Copper
Nominal cross section	4 mm ²
Solid conductor	0.2 ... 4 mm ² / 24 ... 12 AWG
Stranded conductor	0.2 ... 4 mm ² / 24 ... 12 AWG
Fine-stranded conductor	0.14 ... 4 mm ² / 24 ... 12 AWG
Strip length	11 mm / 0.43 inch
Total number of connection points	2
Total number of potentials	1
Type of wiring	Side-entry wiring
Leiterquerschnitte eindrätig	0.2 mm ²

Geometrical Data

Width	13.1 mm / 0.516 inch
Height	8.3 mm / 0.327 inch
Depth	18.6 mm / 0.732 inch

Material Data

Color	transparent
Flammability class per UL94	V2
Weight	1.6 g

Environmental Requirements



Surrounding air (operating) temperature	85 °C
Continuous operating temperature	105 °C
T-Marking per EN 60998	T85

Commercial data



Product Group	7 (Push Wire Conn.)
Country of origin	DE
GTIN	4050821808435
Customs Tariff No.	85369010000

Approvals / Certificates

Country specific Approvals

Logo	Approval	Additional Approval Text	Certificate name
	CCA DEKRA Certification B.V.	EN 60998	NTR NL-7642
	CCA DEKRA Certification B.V.	EN 60998	71-101731

Ship Approvals

Logo	Approval	Additional Approval Text	Certificate name
	ABS American Bureau of Shipping	-	18-HG1755093-PDA
	DNV GL Det Norske Veritas, Germanischer Lloyd	EN 60998	TAE000015T
	LR Lloyds Register	EN 60998	04/20013 (E8)

UL-Approvals

Logo	Approval	Additional Approval Text	Certificate name
	UL Underwriters Laboratories Inc.	UL 467	E201573









UL
Underwriters Laboratories Inc.

UL 486C

E69654

Compatible products

Mounting adapter

	Item no.: 221-500 Mounting carrier; 221 Series - 4 mm ² ; for DIN-35 rail mounting/screw mounting	www.wago.com/221-500
	Item no.: 221-502 Mounting carrier; for 2-conductor terminal blocks; 221 Series - 4 mm ² ; for screw mounting	www.wago.com/221-502
	Item no.: 221-502/000-004 Mounting carrier; for 2-conductor terminal blocks; 221 Series - 4 mm ² ; for screw mounting	www.wago.com/221-502/000-004
	Item no.: 221-512 Mounting carrier; for 2-conductor terminal blocks; 221 Series - 4 mm ² ; with snap-in mounting foot for horizontal mounting	www.wago.com/221-512
	Item no.: 221-512/000-004 Mounting carrier; for 2-conductor terminal blocks; 221 Series - 4 mm ² ; with snap-in mounting foot for horizontal mounting	www.wago.com/221-512/000-004
	Item no.: 221-522 Mounting carrier; for 2-conductor terminal blocks; 221 Series - 4 mm ² ; with snap-in mounting foot for vertical mounting	www.wago.com/221-522
	Item no.: 221-522/000-004 Mounting carrier; for 2-conductor terminal blocks; 221 Series - 4 mm ² ; with snap-in mounting foot for vertical mounting	www.wago.com/221-522/000-004

Downloads

Documentation

Bid Text

221-412		doc 25.6 kB	Download
---------	--	----------------	----------

Additional Information

Technical explanations	Apr 3, 2019	pdf 2.1 MB	Download
------------------------	-------------	---------------	----------

CAD/CAE - Smart Data



CAD data

3D Download 221-412

URL

Download

EPLAN

EPLAN Data Portal

Download

Subject to changes.