

Data sheet | Item number: 221-613

COMPACT Splicing Connector; for all conductor types; max. 6 mm<sup>2</sup>; 3-conductor; with levers; transparent housing; Surrounding air temperature: max 85°C (T85)

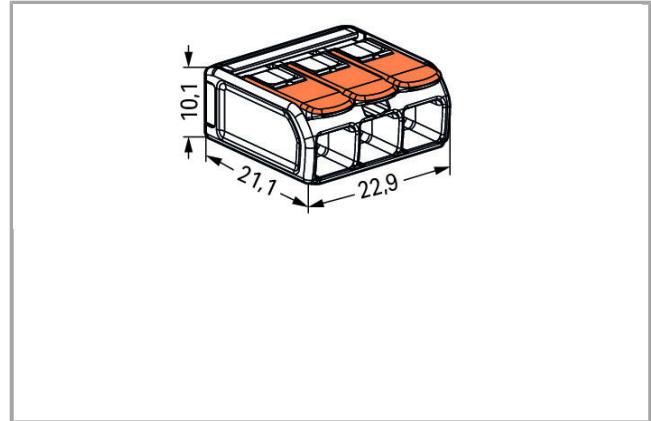

[www.wago.com/221-613](http://www.wago.com/221-613)

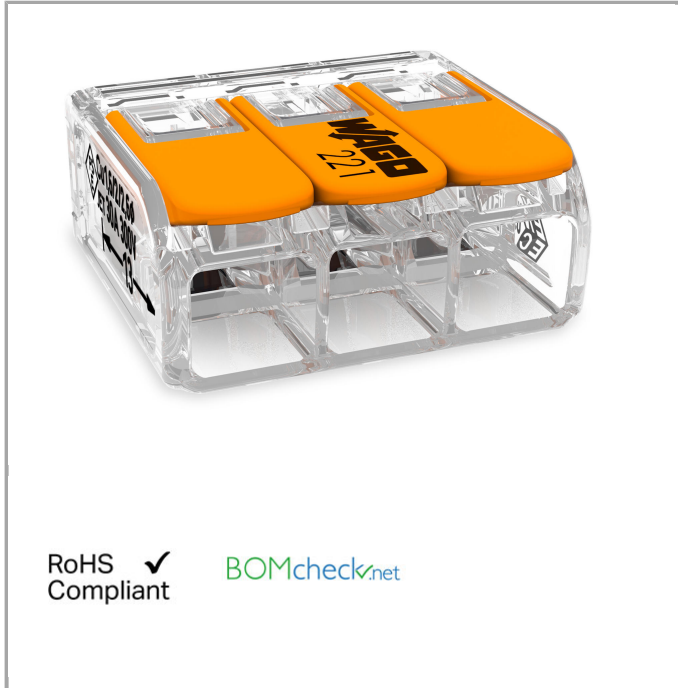

RoHS   
Compliant

[BOMcheck.net](https://www.bomcheck.net)



### Item description

Your Benefits:

- Easy to use: Pull the lever up, insert a conductor and push the lever back down
- Available as 2-, 3- and 5-wire connectors

—



- Easily terminate conductors for all conductors from 0.5 to 6 mm<sup>2</sup> (20 ... 10 AWG).
- Time savings for installers and device manufacturers.
- Quickly install devices with higher levels of power consumption.
- Safely install long cable runs with larger conductor cross sections.
- Mounting carrier for installation conforming to standards
- Custom carriers are possible

**Safety information 1:**

In grounded power lines

**Data****Electrical data****Ratings per IEC/EN 60664-1**

Rated voltage (II / 2)	450 V
Rated impulse voltage (II / 2)	4 kV
Rated current	41 A

**Connection data**

Connection technology	CAGE CLAMP®
Actuation type	Lever
Connectable conductor materials	Copper
Nominal cross section	6 mm <sup>2</sup>
Solid conductor	0.5 ... 6 mm <sup>2</sup> / 20 ... 10 AWG
Stranded conductor	0.5 ... 6 mm <sup>2</sup> / 20 ... 10 AWG
Fine-stranded conductor	0.5 ... 6 mm <sup>2</sup> / 20 ... 10 AWG
Strip length	12 ... 14 mm / 0.47 ... 0.55 inch
Total number of connection points	3
Total number of potentials	1
Type of wiring	Side-entry wiring
Leiterquerschnitte eindrätig	0.5 mm <sup>2</sup>

**Geometrical Data**

Width	22.9 mm / 0.902 inch
Height	10.1 mm / 0.398 inch
Depth	21.1 mm / 0.831 inch

**Material Data**

Color	transparent
Flammability class per UL94	V2

Weight	4.014 g
--------	---------

### Environmental Requirements



Surrounding air (operating) temperature	85 °C
Continuous operating temperature	105 °C
T-Marking per EN 60998	T85

### Commercial data



Country of origin	DE
GTIN	4055143715416

### Approvals / Certificates

#### Ship Approvals

Logo	Approval	Additional Approval Text	Certificate name
	<b>ABS</b> American Bureau of Shipping	EN 60998	18- HG1755093- PDA
	<b>DNV GL</b> Det Norske Veritas, Germanischer Lloyd	EN 60998	TAE000015T
	<b>LR</b> Lloyds Register	EN 60998	04/20013 (E8)

#### UL-Approvals

Logo	Approval	Additional Approval Text	Certificate name
	<b>UL</b> Underwriters Laboratories Inc.	UL 467	E201573
	<b>UL</b> Underwriters Laboratories Inc.	UL 486C	E69654

### Compatible products

#### Mounting adapter



Item no.: 221-510

Mounting carrier; 221 Series - 6 mm<sup>2</sup>; for DIN-35 rail mounting/screw mounting

[www.wago.com/221-510](http://www.wago.com/221-510)

## Downloads

### Documentation

#### Additional Information

Technical explanations	Apr 3, 2019	pdf 2.1 MB	Download
------------------------	-------------	---------------	----------

## CAD/CAE - Smart Data

### CAD data

3D Download 221-613	URL	Download
---------------------	-----	----------

Subject to changes.