

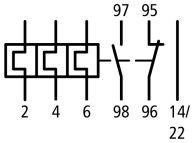

Overload relay, ZB32, I<sub>r</sub>= 0.6 - 1 A, 1 N/O, 1 N/C, Direct mounting, IP20

Part no. **ZB32-1**  
 Catalog No. **278446**  
 Alternate Catalog No. **XTOB001CC1**  
 EL-Nummer **0004131841**  
 (Norway)

**Delivery program**

|  |                |   |  |
|--|----------------|---|--|
| Product range  |                |   | Overload relay ZB up to 150 A  |
| Product range  |                |   | Accessories  |
| Accessories  |                |   | Overload relays  |
| Frame size   |                |   | ZB32   |
| Phase-failure sensitivity  |                |   | IEC/EN 60947, VDE 0660 Part 102  |
| Description  |                |   | Test/off button<br>Reset pushbutton manual/auto<br>Trip-free release   |
| Mounting type  |                |   | Direct mounting  |
|                              | I <sub>r</sub> | A | 0.6 - 1  |
| Contact sequence   |                |   |    |
| <b>Auxiliary contacts</b>  |                |   |  |
| N/O = Normally open  |                |   | 1 N/O  |
| N/C = Normally closed  |                |   | 1 N/C  |
| For use with   |                |   | DILM17, DILM25,<br>DILM32,<br>DILM38,<br>DILMF8,<br>DILMF11,<br>DILMF14,<br>DILMF17,<br>DILMF25,<br>DILMF32,<br>DIULM17, DIULM25,<br>DIULM32,<br>SDAINLM30,<br>SDAINLM45,<br>SDAINLM55 |
| <b>Short-circuit protection</b>  |                |   |  |
| Type "1" coordination<br> | gG/gL          | A | 25   |
| Type "2" coordination<br> | gG/gL          | A | 4  |

**Notes**

Overload release: tripping class 10 A

short-circuit protective device: Observe the maximum permissible fuse of the contactor with direct device mounting.

Suitable for protection of Ex e-motors.



II(2)G [Ex d] [Ex e] [Ex px], II(2)D [Ex p] [Ex t]

PTB 10 ATEX 3010

**Notes**

Fitted directly to the contactor

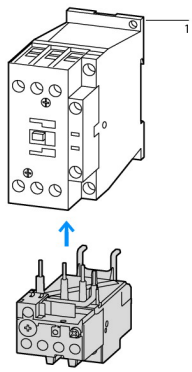

Separate mounting



1 Contactor  
2 Bases

**Technical data**

**General**

|   |  |    |  |
|---|--|----|--|
| Standards   |  |    | IEC/EN 60947, VDE 0660, UL, CSA  |
| Climatic proofing   |  |    | Damp heat, constant, to IEC 60068-2-78<br>Damp heat, cyclic, to IEC 60068-2-30 |
| Ambient temperature   |  |    |  |
|   |  |    | Operating range to IEC/EN 60947<br>PTB: -5 °C - +55 °C                         |
| Open  |  | °C | -25 - +55  |
| Enclosed  |  | °C | -25 - 40   |
| Temperature compensation  |  |    | Continuous   |
| Weight  |  | kg | 0.142  |
| Mechanical shock resistance   |  | g  | 10<br>Sinusoidal<br>Shock duration 10 ms                                       |
| Degree of Protection  |  |    | IP20   |
| Protection against direct contact when actuated from front (EN 50274) |  |    | Finger and back-of-hand proof  |

**Main conducting paths**

|  |           |                 |                            |
|--|-----------|-----------------|----------------------------|
| Rated impulse withstand voltage                | $U_{imp}$ | V AC            | 6000                       |
| Overvoltage category/pollution degree          |           |                 | III/3                      |
| Rated insulation voltage                       | $U_i$     | V               | 690                        |
| Rated operational voltage                      | $U_e$     | V AC            | 690                        |
| Safe isolation to EN 61140                     |           |                 |                            |
| Between auxiliary contacts and main contacts   |           | V AC            | 440                        |
| Between main circuits                          |           | V AC            | 440                        |
| Temperatur compensation residual error > 40 °C |           |                 | $\leq 0.25 \%/K$           |
| Current heat loss (3 conductors)               |           |                 |                            |
| Lower value of the setting range               |           | W               | 2.5                        |
| Maximum setting                                |           | W               | 6.9                        |
| Terminal capacities                            |           | mm <sup>2</sup> |                            |
| Solid  |           | mm <sup>2</sup> | 1 x (1 - 6)<br>2 x (1 - 6) |
| Flexible with ferrule                          |           | mm <sup>2</sup> | 1 x (1 - 4)<br>2 x (1 - 4) |
| ein- oder mehrdrähtig                          |           | AWG             | 18 - 8                     |
| Terminal screw                                 |           |                 | M4                         |
| Tightening torque                              |           | Nm              | 1.8                        |
| Stripping length                               |           | mm              | 10                         |
| Tools  |           |                 |                            |

|                                       |           |                 |   |
|---------------------------------------|-----------|-----------------|---|
| Pozidriv screwdriver                  |           | Size            | 2   |
| Standard screwdriver                  |           | mm              | 1 x 6   |
| <b>Auxiliary and control circuits</b> |           |                 |   |
| Rated impulse withstand voltage       | $U_{imp}$ | V               | 4000  |
| Overvoltage category/pollution degree |           |                 | III/3   |
| Terminal capacities                   |           | mm <sup>2</sup> |   |
| Solid                                 |           | mm <sup>2</sup> | 1 x (0.75 - 4)<br>2 x (0.75 - 4)  |
| Flexible with ferrule                 |           | mm <sup>2</sup> | 1 x (0.75 - 2.5)<br>2 x (0.75 - 2.5)  |
| Solid or stranded                     |           | AWG             | 2 x (18 - 14)   |
| Terminal screw                        |           |                 | M3.5  |
| Tightening torque                     |           | Nm              | 1.2   |
| Stripping length                      |           | mm              | 8   |
| Tools                                 |           |                 |   |
| Pozidriv screwdriver                  |           | Size            | 2   |
| Standard screwdriver                  |           | mm              | 1 x 6   |
| Rated insulation voltage              | $U_i$     | V AC            | 500   |
| Rated operational voltage             | $U_e$     | V AC            | 500   |
| Safe isolation to EN 61140            |           |                 |   |
| between the auxiliary contacts        |           | V AC            | 240   |
| Conventional thermal current          | $I_{th}$  | A               | 6   |
| Rated operational current             | $I_e$     | A               |   |
| AC-15                                 |           |                 |   |
| Make contact                          |           |                 |   |
| 120 V                                 | $I_e$     | A               | 1.5   |
| 220 V 230 V 240 V                     | $I_e$     | A               | 1.5   |
| 380 V 400 V 415 V                     | $I_e$     | A               | 0.5   |
| 500 V                                 | $I_e$     | A               | 0.5   |
| Break contact                         |           |                 |   |
| 120 V                                 | $I_e$     | A               | 1.5   |
| 220 V 230 V 240 V                     | $I_e$     | A               | 1.5   |
| 380 V 400 V 415 V                     | $I_e$     | A               | 0.9   |
| 500 V                                 | $I_e$     | A               | 0.8   |
| DC L/R ≤ 15 ms                        |           |                 |   |
|                                       |           |                 | Switch-on and switch-off conditions based on DC-13, time constant as specified. |
| 24 V                                  | $I_e$     | A               | 0.9   |
| 60 V                                  | $I_e$     | A               | 0.75  |
| 110 V                                 | $I_e$     | A               | 0.4   |
| 220 V                                 | $I_e$     | A               | 0.2   |
| Short-circuit rating without welding  |           |                 |   |
| max. fuse                             |           | A gG/gL         | 6   |

## Notes

**Notes** Ambient air temperature: Operating range to IEC/EN 60947, PTB: -5°C to +55°C  
Main circuits terminal capacity solid and flexible conductors with ferrules: When using 2 conductors use equal cross-sections.

## Rating data for approved types

|                              |  |      |  |
|------------------------------|--|------|--|
| Auxiliary contacts           |  |      |  |
| Pilot Duty                   |  |      |  |
| AC operated                  |  |      | B300 at opposite polarity<br>B600 at same polarity |
| DC operated                  |  |      | R300   |
| Short Circuit Current Rating |  | SCCR |  |
| 600 V High Fault             |  |      |  |
| SCCR (fuse)                  |  | kA   | 100  |
| max. Fuse                    |  | A    | 1 Class J/CC                                       |

## Design verification as per IEC/EN 61439

| Technical data for design verification   |            |    |  |
|--|------------|----|--|
| Rated operational current for specified heat dissipation   | $I_n$      | A  | 1  |
| Heat dissipation per pole, current-dependent   | $P_{vid}$  | W  | 2.3  |
| Equipment heat dissipation, current-dependent  | $P_{vid}$  | W  | 6.9  |
| Static heat dissipation, non-current-dependent   | $P_{vs}$   | W  | 0  |
| Heat dissipation capacity  | $P_{diss}$ | W  | 0  |
| Operating ambient temperature min.   |            | °C | -25  |
| Operating ambient temperature max.   |            | °C | 55   |
| IEC/EN 61439 design verification   |            |    |  |
| 10.2 Strength of materials and parts   |            |    |  |
| 10.2.2 Corrosion resistance  |            |    |  |
|  |            |    | Meets the product standard's requirements.   |
| 10.2.3.1 Verification of thermal stability of enclosures   |            |    |  |
|  |            |    | Meets the product standard's requirements.   |
| 10.2.3.2 Verification of resistance of insulating materials to normal heat   |            |    |  |
|  |            |    | Meets the product standard's requirements.   |
| 10.2.3.3 Verification of resistance of insulating materials to abnormal heat and fire due to internal electric effects |            |    |  |
|  |            |    | Meets the product standard's requirements.   |
| 10.2.4 Resistance to ultra-violet (UV) radiation   |            |    |  |
|  |            |    | Meets the product standard's requirements.   |
| 10.2.5 Lifting   |            |    |  |
|  |            |    | Does not apply, since the entire switchgear needs to be evaluated.   |
| 10.2.6 Mechanical impact   |            |    |  |
|  |            |    | Does not apply, since the entire switchgear needs to be evaluated.   |
| 10.2.7 Inscriptions  |            |    |  |
|  |            |    | Meets the product standard's requirements.   |
| 10.3 Degree of protection of ASSEMBLIES  |            |    |  |
|  |            |    | Does not apply, since the entire switchgear needs to be evaluated.   |
| 10.4 Clearances and creepage distances   |            |    |  |
|  |            |    | Meets the product standard's requirements.   |
| 10.5 Protection against electric shock   |            |    |  |
|  |            |    | Does not apply, since the entire switchgear needs to be evaluated.   |
| 10.6 Incorporation of switching devices and components   |            |    |  |
|  |            |    | Does not apply, since the entire switchgear needs to be evaluated.   |
| 10.7 Internal electrical circuits and connections  |            |    |  |
|  |            |    | Is the panel builder's responsibility.   |
| 10.8 Connections for external conductors   |            |    |  |
|  |            |    | Is the panel builder's responsibility.   |
| 10.9 Insulation properties   |            |    |  |
| 10.9.2 Power-frequency electric strength   |            |    |  |
|  |            |    | Is the panel builder's responsibility.   |
| 10.9.3 Impulse withstand voltage   |            |    |  |
|  |            |    | Is the panel builder's responsibility.   |
| 10.9.4 Testing of enclosures made of insulating material   |            |    |  |
|  |            |    | Is the panel builder's responsibility.   |
| 10.10 Temperature rise   |            |    |  |
|  |            |    | The panel builder is responsible for the temperature rise calculation. Eaton will provide heat dissipation data for the devices. |
| 10.11 Short-circuit rating   |            |    |  |
|  |            |    | Is the panel builder's responsibility. The specifications for the switchgear must be observed.                                   |
| 10.12 Electromagnetic compatibility  |            |    |  |
|  |            |    | Is the panel builder's responsibility. The specifications for the switchgear must be observed.                                   |
| 10.13 Mechanical function  |            |    |  |
|  |            |    | The device meets the requirements, provided the information in the instruction leaflet (IL) is observed.                         |

## Technical data ETIM 7.0

| Low-voltage industrial components (EG000017) / Thermal overload relay (EC000106)   |  |   |                   |
|--|--|---|-------------------|
| Electric engineering, automation, process control engineering / Low-voltage switch technology / Overload protection device / Thermal overload relay (ecl@ss10.0.1-27-37-15-01 [AKF075014]) |  |   |                   |
| Adjustable current range   |  | A | 0.6 - 1           |
| Max. rated operation voltage $U_e$   |  | V | 690               |
| Mounting method  |  |   | Direct attachment |
| Type of electrical connection of main circuit  |  |   | Screw connection  |
| Number of auxiliary contacts as normally closed contact  |  |   | 1                 |
| Number of auxiliary contacts as normally open contact  |  |   | 1                 |
| Number of auxiliary contacts as change-over contact  |  |   | 0                 |
| Release class  |  |   | CLASS 10          |
| Reset function input   |  |   | No                |
| Reset function automatic   |  |   | Yes               |
| Reset function push-button   |  |   | Yes               |

## Approvals

|                   |  |  |  |
|-------------------|--|--|--|
| Product Standards |  |  | IEC/EN 60947-4-1; UL 60947-4-1; CSA - C22.2 No. 60947-4-1-14; CE marking |
| UL File No.       |  |  | E29184   |

|                                      |  |                           |
|--------------------------------------|--|---------------------------|
| UL Category Control No.              |  | NKCR                      |
| CSA File No.                         |  | 12528                     |
| CSA Class No.                        |  | 3211-03                   |
| North America Certification          |  | UL listed, CSA certified  |
| Specially designed for North America |  | No                        |
| Suitable for                         |  | Branch circuits           |
| Max. Voltage Rating                  |  | 600 V AC                  |
| Degree of Protection                 |  | IEC: IP20, UL/CSA Type: - |

## Characteristics

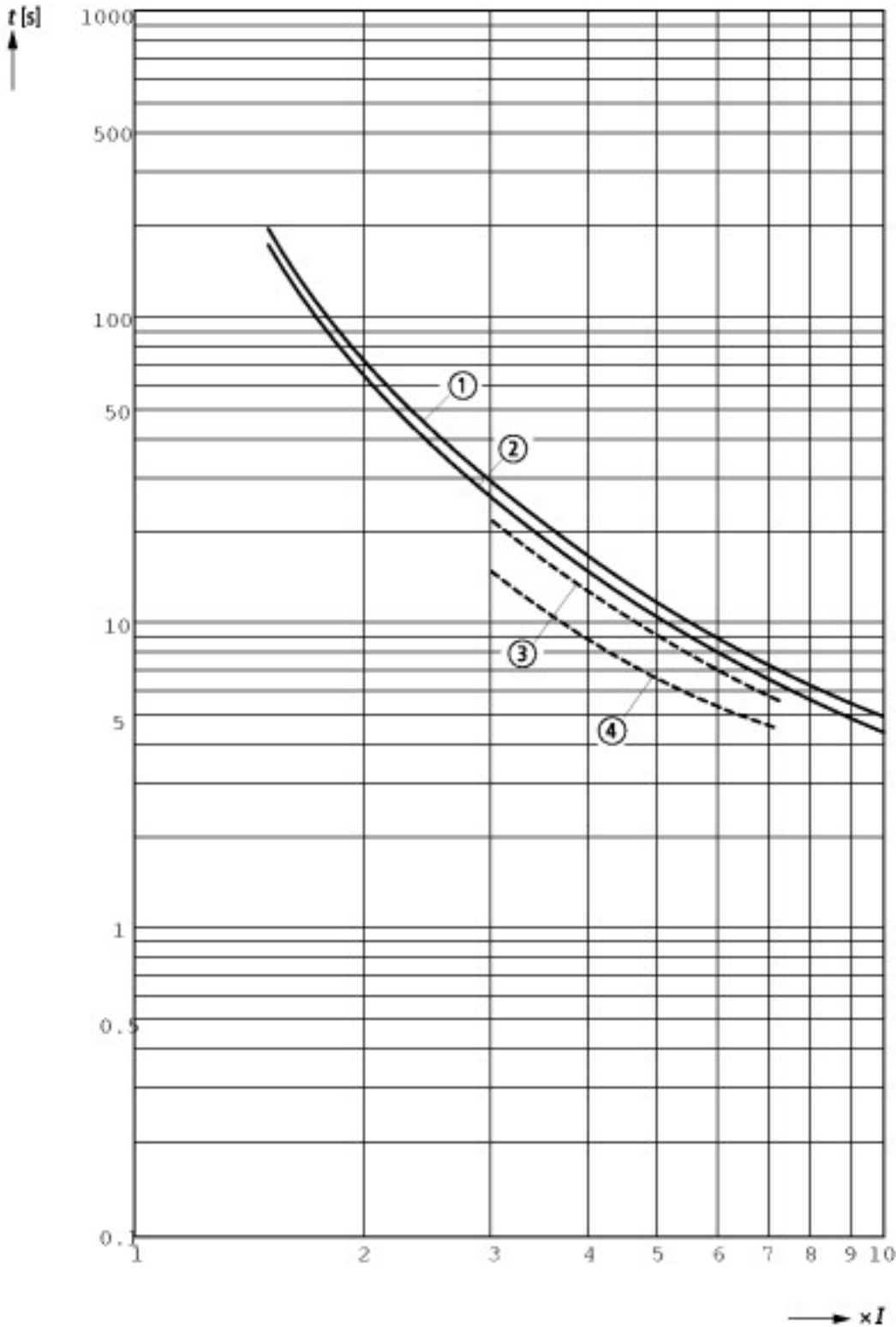

These tripping characteristics are mean values of the spreads at 20 °C ambient air temperature in a cold state.

Tripping time depends on response current.

When the devices are at operational temperature the tripping time of the overload relay falls to approx. 25 % of the read off value.

- 1: Minimum level, 3-phase
- 2: Maximum level, 3-phase
- 3: Minimum marker, 2-phase
- 4: Highest marker, 2-phase

## Dimensions

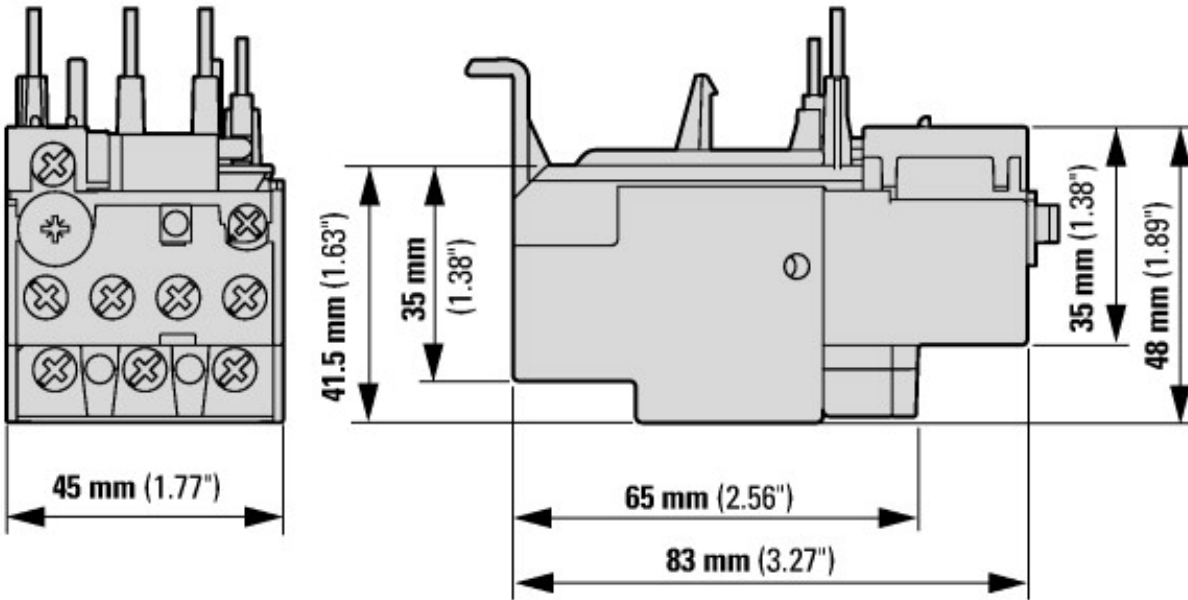

- ① OFF
- ② Reset/ON



With base ZB32-XEZ



ZB32... + DILM

## Assets (links)

### Declaration of CE Conformity

00002848

### Instruction Leaflets

IL03407015Z2018\_04

### Manuals

MN03407004Z\_DE\_EN (German)

MN03407004Z\_DE\_EN (English)

## Additional product information (links)

### IL03407015Z (AWA2300-2114) Overload relay

IL03407015Z (AWA2300-2114) Overload relay [ftp://ftp.moeller.net/DOCUMENTATION/AWA\\_INSTRUCTIONS/IL03407015Z2018\\_04.pdf](ftp://ftp.moeller.net/DOCUMENTATION/AWA_INSTRUCTIONS/IL03407015Z2018_04.pdf)

### IL03407195Z Sealable shroud

IL03407195Z Sealable shroud [ftp://ftp.moeller.net/DOCUMENTATION/AWA\\_INSTRUCTIONS/IL03407195Z2018\\_06.pdf](ftp://ftp.moeller.net/DOCUMENTATION/AWA_INSTRUCTIONS/IL03407195Z2018_06.pdf)

### MN03407004Z (AWB2300-1527D/GB) ZB12/XTOB...BC1 and ZB32/XTOB...CC1 overload relays, overload monitoring of Ex e motors

MN03407004Z (AWB2300-1527D/GB) ZB12/XTOB...BC1 and ZB32/XTOB...CC1 overload relays, overload monitoring of Ex e motors - Deutsch / English [ftp://ftp.moeller.net/DOCUMENTATION/AWB\\_MANUALS/MN03407004Z\\_DE\\_EN.pdf](ftp://ftp.moeller.net/DOCUMENTATION/AWB_MANUALS/MN03407004Z_DE_EN.pdf)