

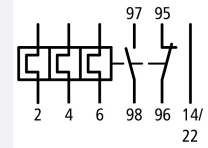

Overload relay, ZB32, I_r= 1.6 - 2.4 A, 1 N/O, 1 N/C, Direct mounting, IP20

Part no. **ZB32-2,4**
 Catalog No. **278448**
 Alternate Catalog No. **XTOB2P4CC1**
 EL-Nummer **0004131843**
 (Norway)

Delivery program

| | | | |
|--|----------------|---|--|
| Product range | | | Overload relay ZB up to 150 A |
| Product range | | | Accessories |
| Accessories | | | Overload relays |
| Frame size | | | ZB32 |
| Phase-failure sensitivity | | | IEC/EN 60947, VDE 0660 Part 102 |
| Description | | | Test/off button Reset pushbutton manual/auto Trip-free release |
| Mounting type | | | Direct mounting |
|  | I _r | A | 1.6 - 2.4 |
| Contact sequence | | |  |
| Auxiliary contacts | | | |
| N/O = Normally open | | | 1 N/O |
| N/C = Normally closed | | | 1 N/C |
| For use with | | | DILM17, DILM25, DILM32, DILM38, DILMF8, DILMF11, DILMF14, DILMF17, DILMF25, DILMF32, DIULM17, DIULM25, DIULM32, SDAINLM30, SDAINLM45, SDAINLM55 |
| Short-circuit protection | | | |
| Type "1" coordination  | gG/gL | A | 25 |
| Type "2" coordination  | gG/gL | A | 10 |

Notes

Overload release: tripping class 10 A

short-circuit protective device: Observe the maximum permissible fuse of the contactor with direct device mounting.

Suitable for protection of Ex e-motors.



II(2)G [Ex d] [Ex e] [Ex px], II(2)D [Ex p] [Ex t]

PTB 10 ATEX 3010

Notes

Fitted directly to the contactor

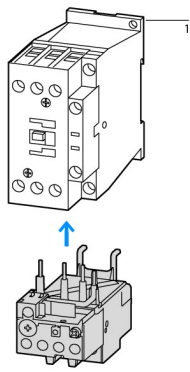

Separate mounting

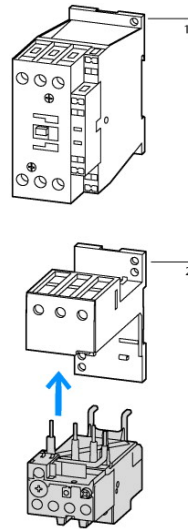

1 Contactor
2 Bases

Technical data

General

| | | | |
|---|--|----|--|
| Standards | | | IEC/EN 60947, VDE 0660, UL, CSA |
| Climatic proofing | | | Damp heat, constant, to IEC 60068-2-78 Damp heat, cyclic, to IEC 60068-2-30 |
| Ambient temperature | | | |
| | | | Operating range to IEC/EN 60947 PTB: -5 °C - +55 °C |
| Open | | °C | -25 - +55 |
| Enclosed | | °C | -25 - 40 |
| Temperature compensation | | | Continuous |
| Weight | | kg | 0.142 |
| Mechanical shock resistance | | g | 10 Sinusoidal Shock duration 10 ms |
| Degree of Protection | | | IP20 |
| Protection against direct contact when actuated from front (EN 50274) | | | Finger and back-of-hand proof |

Main conducting paths

| | | | |
|--|-----------|-----------------|----------------------------|
| Rated impulse withstand voltage | U_{imp} | V AC | 6000 |
| Overvoltage category/pollution degree | | | III/3 |
| Rated insulation voltage | U_i | V | 690 |
| Rated operational voltage | U_e | V AC | 690 |
| Safe isolation to EN 61140 | | | |
| Between auxiliary contacts and main contacts | | V AC | 440 |
| Between main circuits | | V AC | 440 |
| Temperatur compensation residual error > 40 °C | | | $\leq 0.25 \%/K$ |
| Current heat loss (3 conductors) | | | |
| Lower value of the setting range | | W | 2.5 |
| Maximum setting | | W | 5.7 |
| Terminal capacities | | mm ² | |
| Solid | | mm ² | 1 x (1 - 6) 2 x (1 - 6) |
| Flexible with ferrule | | mm ² | 1 x (1 - 4) 2 x (1 - 4) |
| ein- oder mehrdrähtig | | AWG | 18 - 8 |
| Terminal screw | | | M4 |
| Tightening torque | | Nm | 1.8 |
| Stripping length | | mm | 10 |
| Tools | | | |

| | | | |
|---------------------------------------|-----------|-----------------|---|
| Pozidriv screwdriver | | Size | 2 |
| Standard screwdriver | | mm | 1 x 6 |
| Auxiliary and control circuits | | | |
| Rated impulse withstand voltage | U_{imp} | V | 4000 |
| Overvoltage category/pollution degree | | | III/3 |
| Terminal capacities | | mm ² | |
| Solid | | mm ² | 1 x (0.75 - 4) 2 x (0.75 - 4) |
| Flexible with ferrule | | mm ² | 1 x (0.75 - 2.5) 2 x (0.75 - 2.5) |
| Solid or stranded | | AWG | 2 x (18 - 14) |
| Terminal screw | | | M3.5 |
| Tightening torque | | Nm | 1.2 |
| Stripping length | | mm | 8 |
| Tools | | | |
| Pozidriv screwdriver | | Size | 2 |
| Standard screwdriver | | mm | 1 x 6 |
| Rated insulation voltage | U_i | V AC | 500 |
| Rated operational voltage | U_e | V AC | 500 |
| Safe isolation to EN 61140 | | | |
| between the auxiliary contacts | | V AC | 240 |
| Conventional thermal current | I_{th} | A | 6 |
| Rated operational current | I_e | A | |
| AC-15 | | | |
| Make contact | | | |
| 120 V | I_e | A | 1.5 |
| 220 V 230 V 240 V | I_e | A | 1.5 |
| 380 V 400 V 415 V | I_e | A | 0.5 |
| 500 V | I_e | A | 0.5 |
| Break contact | | | |
| 120 V | I_e | A | 1.5 |
| 220 V 230 V 240 V | I_e | A | 1.5 |
| 380 V 400 V 415 V | I_e | A | 0.9 |
| 500 V | I_e | A | 0.8 |
| DC L/R ≤ 15 ms | | | |
| | | | Switch-on and switch-off conditions based on DC-13, time constant as specified. |
| 24 V | I_e | A | 0.9 |
| 60 V | I_e | A | 0.75 |
| 110 V | I_e | A | 0.4 |
| 220 V | I_e | A | 0.2 |
| Short-circuit rating without welding | | | |
| max. fuse | | A gG/gL | 6 |

Notes

Notes Ambient air temperature: Operating range to IEC/EN 60947, PTB: -5°C to +55°C
Main circuits terminal capacity solid and flexible conductors with ferrules: When using 2 conductors use equal cross-sections.

Rating data for approved types

| | | | |
|------------------------------|--|------|--|
| Auxiliary contacts | | | |
| Pilot Duty | | | |
| AC operated | | | B300 at opposite polarity B600 at same polarity |
| DC operated | | | R300 |
| Short Circuit Current Rating | | SCCR | |
| 600 V High Fault | | | |
| SCCR (fuse) | | kA | 100 |
| max. Fuse | | A | 3 Class J/CC |

Design verification as per IEC/EN 61439

| Technical data for design verification | | | |
|--|------------|----|--|
| Rated operational current for specified heat dissipation | I_n | A | 2.4 |
| Heat dissipation per pole, current-dependent | P_{vid} | W | 1.9 |
| Equipment heat dissipation, current-dependent | P_{vid} | W | 5.7 |
| Static heat dissipation, non-current-dependent | P_{vs} | W | 0 |
| Heat dissipation capacity | P_{diss} | W | 0 |
| Operating ambient temperature min. | | °C | -25 |
| Operating ambient temperature max. | | °C | 55 |
| IEC/EN 61439 design verification | | | |
| 10.2 Strength of materials and parts | | | |
| 10.2.2 Corrosion resistance | | | |
| | | | Meets the product standard's requirements. |
| 10.2.3.1 Verification of thermal stability of enclosures | | | |
| | | | Meets the product standard's requirements. |
| 10.2.3.2 Verification of resistance of insulating materials to normal heat | | | |
| | | | Meets the product standard's requirements. |
| 10.2.3.3 Verification of resistance of insulating materials to abnormal heat and fire due to internal electric effects | | | |
| | | | Meets the product standard's requirements. |
| 10.2.4 Resistance to ultra-violet (UV) radiation | | | |
| | | | Meets the product standard's requirements. |
| 10.2.5 Lifting | | | |
| | | | Does not apply, since the entire switchgear needs to be evaluated. |
| 10.2.6 Mechanical impact | | | |
| | | | Does not apply, since the entire switchgear needs to be evaluated. |
| 10.2.7 Inscriptions | | | |
| | | | Meets the product standard's requirements. |
| 10.3 Degree of protection of ASSEMBLIES | | | |
| | | | Does not apply, since the entire switchgear needs to be evaluated. |
| 10.4 Clearances and creepage distances | | | |
| | | | Meets the product standard's requirements. |
| 10.5 Protection against electric shock | | | |
| | | | Does not apply, since the entire switchgear needs to be evaluated. |
| 10.6 Incorporation of switching devices and components | | | |
| | | | Does not apply, since the entire switchgear needs to be evaluated. |
| 10.7 Internal electrical circuits and connections | | | |
| | | | Is the panel builder's responsibility. |
| 10.8 Connections for external conductors | | | |
| | | | Is the panel builder's responsibility. |
| 10.9 Insulation properties | | | |
| 10.9.2 Power-frequency electric strength | | | |
| | | | Is the panel builder's responsibility. |
| 10.9.3 Impulse withstand voltage | | | |
| | | | Is the panel builder's responsibility. |
| 10.9.4 Testing of enclosures made of insulating material | | | |
| | | | Is the panel builder's responsibility. |
| 10.10 Temperature rise | | | |
| | | | The panel builder is responsible for the temperature rise calculation. Eaton will provide heat dissipation data for the devices. |
| 10.11 Short-circuit rating | | | |
| | | | Is the panel builder's responsibility. The specifications for the switchgear must be observed. |
| 10.12 Electromagnetic compatibility | | | |
| | | | Is the panel builder's responsibility. The specifications for the switchgear must be observed. |
| 10.13 Mechanical function | | | |
| | | | The device meets the requirements, provided the information in the instruction leaflet (IL) is observed. |

Technical data ETIM 7.0

| Low-voltage industrial components (EG000017) / Thermal overload relay (EC000106) | | | |
|--|--|---|-------------------|
| Electric engineering, automation, process control engineering / Low-voltage switch technology / Overload protection device / Thermal overload relay (ecl@ss10.0.1-27-37-15-01 [AKF075014]) | | | |
| Adjustable current range | | A | 1.6 - 2.4 |
| Max. rated operation voltage U_e | | V | 690 |
| Mounting method | | | Direct attachment |
| Type of electrical connection of main circuit | | | Screw connection |
| Number of auxiliary contacts as normally closed contact | | | 1 |
| Number of auxiliary contacts as normally open contact | | | 1 |
| Number of auxiliary contacts as change-over contact | | | 0 |
| Release class | | | CLASS 10 |
| Reset function input | | | No |
| Reset function automatic | | | Yes |
| Reset function push-button | | | Yes |

Approvals

| | | | |
|-------------------|--|--|--|
| Product Standards | | | IEC/EN 60947-4-1; UL 60947-4-1; CSA - C22.2 No. 60947-4-1-14; CE marking |
| UL File No. | | | E29184 |

| | | |
|--------------------------------------|--|---------------------------|
| UL Category Control No. | | NKCR |
| CSA File No. | | 12528 |
| CSA Class No. | | 3211-03 |
| North America Certification | | UL listed, CSA certified |
| Specially designed for North America | | No |
| Suitable for | | Branch circuits |
| Max. Voltage Rating | | 600 V AC |
| Degree of Protection | | IEC: IP20, UL/CSA Type: - |

Characteristics

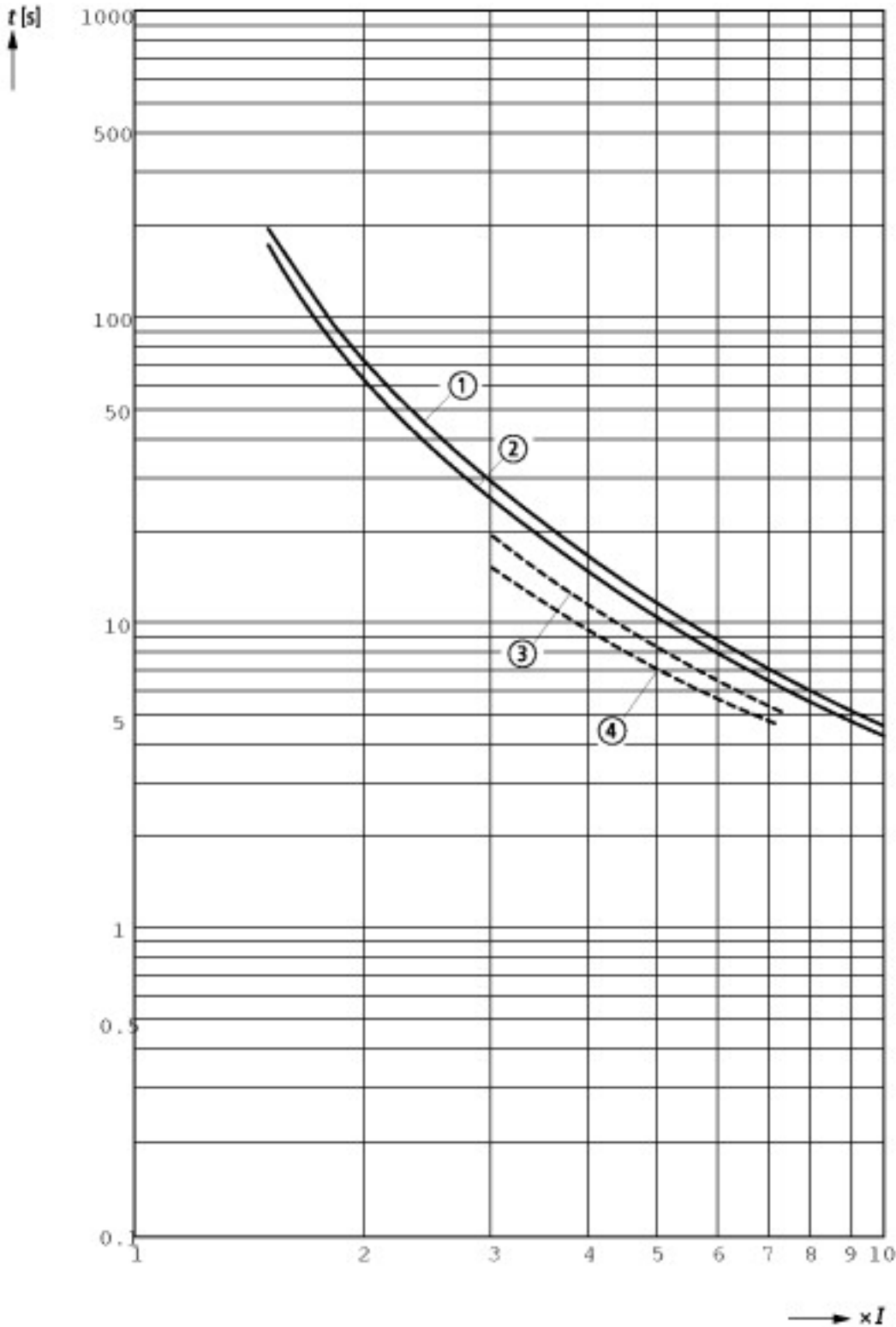

These tripping characteristics are mean values of the spreads at 20 °C ambient air temperature in a cold state.

Tripping time depends on response current.

When the devices are at operational temperature the tripping time of the overload relay falls to approx. 25 % of the read off value.

- 1: Minimum level, 3-phase
- 2: Maximum level, 3-phase
- 3: Minimum marker, 2-phase
- 4: Highest marker, 2-phase

Dimensions

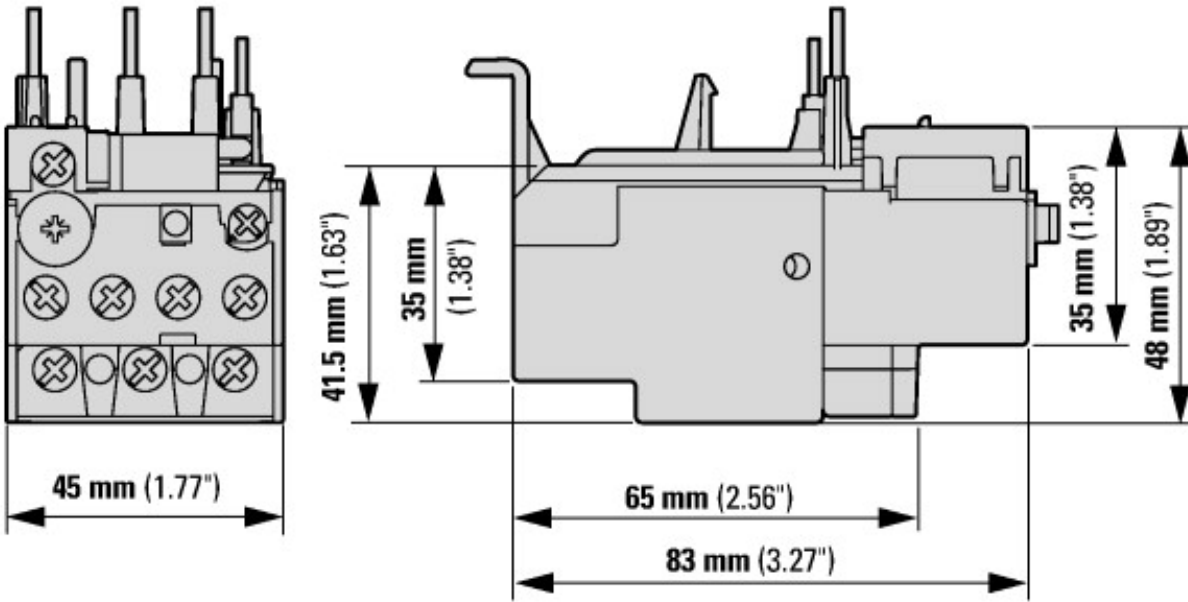

- ① OFF
- ② Reset/ON

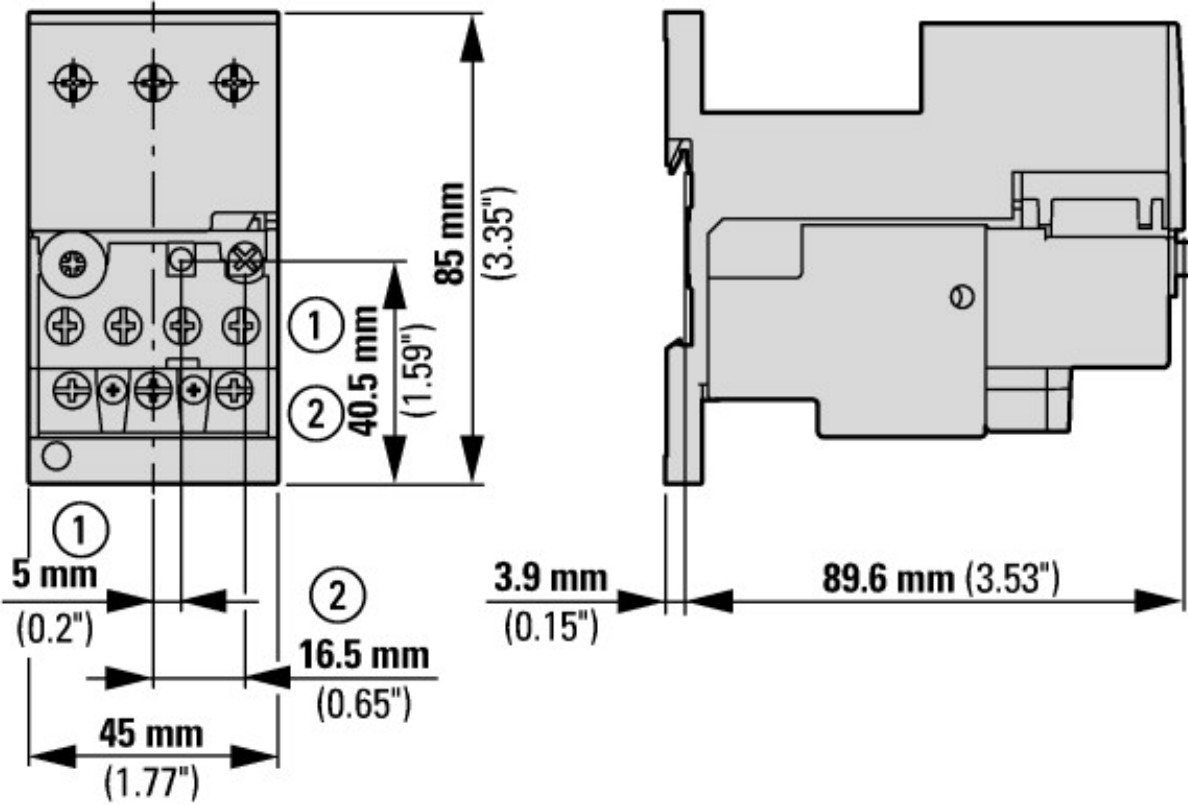

With base ZB32-XEZ



ZB32... + DILM

Assets (links)

Declaration of CE Conformity

00002848

Instruction Leaflets

IL03407015Z2018_04

Manuals

MN03407004Z_DE_EN (German)

MN03407004Z_DE_EN (English)

Additional product information (links)

IL03407015Z (AWA2300-2114) Overload relay

IL03407015Z (AWA2300-2114) Overload relay ftp://ftp.moeller.net/DOCUMENTATION/AWA_INSTRUCTIONS/IL03407015Z2018_04.pdf

IL03407195Z Sealable shroud

IL03407195Z Sealable shroud ftp://ftp.moeller.net/DOCUMENTATION/AWA_INSTRUCTIONS/IL03407195Z2018_06.pdf

MN03407004Z (AWB2300-1527D/GB) ZB12/XTOB...BC1 and ZB32/XTOB...CC1 overload relays, overload monitoring of Ex e motors

MN03407004Z (AWB2300-1527D/GB) ZB12/XTOB...BC1 and ZB32/XTOB...CC1 overload relays, overload monitoring of Ex e motors - Deutsch / English ftp://ftp.moeller.net/DOCUMENTATION/AWB_MANUALS/MN03407004Z_DE_EN.pdf