

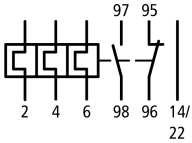

Overload relay, ZB32, I_r= 2.4 - 4 A, 1 N/O, 1 N/C, Direct mounting, IP20

Part no. **ZB32-4**
 Catalog No. **278449**
 Alternate Catalog No. **XTOB004CC1**
 EL-Nummer **0004131844**
 (Norway)

Delivery program

Product range			Overload relay ZB up to 150 A
Product range			Accessories
Accessories			Overload relays
Frame size			ZB32
Phase-failure sensitivity			IEC/EN 60947, VDE 0660 Part 102
Description			Test/off button Reset pushbutton manual/auto Trip-free release
Mounting type			Direct mounting
	I _r	A	2.4 - 4
Contact sequence			
Auxiliary contacts			
N/O = Normally open			1 N/O
N/C = Normally closed			1 N/C
For use with			DILM17, DILM25, DILM32, DILM38, DILMF8, DILMF11, DILMF14, DILMF17, DILMF25, DILMF32, DIULM17, DIULM25, DIULM32, SDAINLM30, SDAINLM45, SDAINLM55
Short-circuit protection			
Type "1" coordination 	gG/gL	A	25
Type "2" coordination 	gG/gL	A	16

Notes

Overload release: tripping class 10 A

short-circuit protective device: Observe the maximum permissible fuse of the contactor with direct device mounting.

Suitable for protection of Ex e-motors.



II(2)G [Ex d] [Ex e] [Ex px], II(2)D [Ex p] [Ex t]

PTB 10 ATEX 3010

Notes

Fitted directly to the contactor

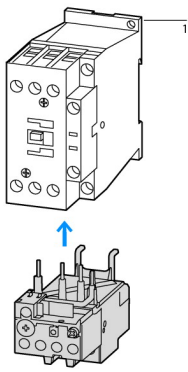

Separate mounting

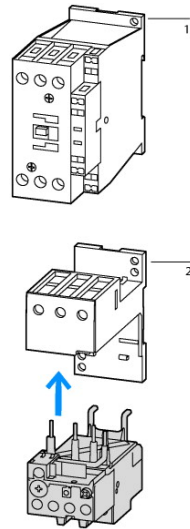

1 Contactor
2 Bases

Technical data

General

Standards			IEC/EN 60947, VDE 0660, UL, CSA
Climatic proofing			Damp heat, constant, to IEC 60068-2-78 Damp heat, cyclic, to IEC 60068-2-30
Ambient temperature			
			Operating range to IEC/EN 60947 PTB: -5 °C - +55 °C
Open		°C	-25 - +55
Enclosed		°C	-25 - 40
Temperature compensation			Continuous
Weight		kg	0.145
Mechanical shock resistance		g	10 Sinusoidal Shock duration 10 ms
Degree of Protection			IP20
Protection against direct contact when actuated from front (EN 50274)			Finger and back-of-hand proof

Main conducting paths

Rated impulse withstand voltage	U_{imp}	V AC	6000
Overvoltage category/pollution degree			III/3
Rated insulation voltage	U_i	V	690
Rated operational voltage	U_e	V AC	690
Safe isolation to EN 61140			
Between auxiliary contacts and main contacts		V AC	440
Between main circuits		V AC	440
Temperatur compensation residual error > 40 °C			$\leq 0.25 \%/K$
Current heat loss (3 conductors)			
Lower value of the setting range		W	2.2
Maximum setting		W	6
Terminal capacities		mm ²	
Solid		mm ²	1 x (1 - 6) 2 x (1 - 6)
Flexible with ferrule		mm ²	1 x (1 - 4) 2 x (1 - 4)
ein- oder mehrdrähtig		AWG	18 - 8
Terminal screw			M4
Tightening torque		Nm	1.8
Stripping length		mm	10
Tools			

Pozidriv screwdriver		Size	2
Standard screwdriver		mm	1 x 6
Auxiliary and control circuits			
Rated impulse withstand voltage	U_{imp}	V	4000
Overvoltage category/pollution degree			III/3
Terminal capacities		mm ²	
Solid		mm ²	1 x (0.75 - 4) 2 x (0.75 - 4)
Flexible with ferrule		mm ²	1 x (0.75 - 2.5) 2 x (0.75 - 2.5)
Solid or stranded		AWG	2 x (18 - 14)
Terminal screw			M3.5
Tightening torque		Nm	1.2
Stripping length		mm	8
Tools			
Pozidriv screwdriver		Size	2
Standard screwdriver		mm	1 x 6
Rated insulation voltage	U_i	V AC	500
Rated operational voltage	U_e	V AC	500
Safe isolation to EN 61140			
between the auxiliary contacts		V AC	240
Conventional thermal current	I_{th}	A	6
Rated operational current	I_e	A	
AC-15			
Make contact			
120 V	I_e	A	1.5
220 V 230 V 240 V	I_e	A	1.5
380 V 400 V 415 V	I_e	A	0.5
500 V	I_e	A	0.5
Break contact			
120 V	I_e	A	1.5
220 V 230 V 240 V	I_e	A	1.5
380 V 400 V 415 V	I_e	A	0.9
500 V	I_e	A	0.8
DC L/R ≤ 15 ms			
			Switch-on and switch-off conditions based on DC-13, time constant as specified.
24 V	I_e	A	0.9
60 V	I_e	A	0.75
110 V	I_e	A	0.4
220 V	I_e	A	0.2
Short-circuit rating without welding			
max. fuse		A gG/gL	6

Notes

Notes Ambient air temperature: Operating range to IEC/EN 60947, PTB: -5°C to +55°C
Main circuits terminal capacity solid and flexible conductors with ferrules: When using 2 conductors use equal cross-sections.

Rating data for approved types

Auxiliary contacts			
Pilot Duty			
AC operated			B300 at opposite polarity B600 at same polarity
DC operated			R300
Short Circuit Current Rating		SCCR	
600 V High Fault			
SCCR (fuse)		kA	100
max. Fuse		A	6 Class J/CC

Design verification as per IEC/EN 61439

Technical data for design verification			
Rated operational current for specified heat dissipation	I_n	A	4
Heat dissipation per pole, current-dependent	P_{vid}	W	2
Equipment heat dissipation, current-dependent	P_{vid}	W	6
Static heat dissipation, non-current-dependent	P_{vs}	W	0
Heat dissipation capacity	P_{diss}	W	0
Operating ambient temperature min.		°C	-25
Operating ambient temperature max.		°C	55
IEC/EN 61439 design verification			
10.2 Strength of materials and parts			
10.2.2 Corrosion resistance			
			Meets the product standard's requirements.
10.2.3.1 Verification of thermal stability of enclosures			
			Meets the product standard's requirements.
10.2.3.2 Verification of resistance of insulating materials to normal heat			
			Meets the product standard's requirements.
10.2.3.3 Verification of resistance of insulating materials to abnormal heat and fire due to internal electric effects			
			Meets the product standard's requirements.
10.2.4 Resistance to ultra-violet (UV) radiation			
			Meets the product standard's requirements.
10.2.5 Lifting			
			Does not apply, since the entire switchgear needs to be evaluated.
10.2.6 Mechanical impact			
			Does not apply, since the entire switchgear needs to be evaluated.
10.2.7 Inscriptions			
			Meets the product standard's requirements.
10.3 Degree of protection of ASSEMBLIES			
			Does not apply, since the entire switchgear needs to be evaluated.
10.4 Clearances and creepage distances			
			Meets the product standard's requirements.
10.5 Protection against electric shock			
			Does not apply, since the entire switchgear needs to be evaluated.
10.6 Incorporation of switching devices and components			
			Does not apply, since the entire switchgear needs to be evaluated.
10.7 Internal electrical circuits and connections			
			Is the panel builder's responsibility.
10.8 Connections for external conductors			
			Is the panel builder's responsibility.
10.9 Insulation properties			
10.9.2 Power-frequency electric strength			
			Is the panel builder's responsibility.
10.9.3 Impulse withstand voltage			
			Is the panel builder's responsibility.
10.9.4 Testing of enclosures made of insulating material			
			Is the panel builder's responsibility.
10.10 Temperature rise			
			The panel builder is responsible for the temperature rise calculation. Eaton will provide heat dissipation data for the devices.
10.11 Short-circuit rating			
			Is the panel builder's responsibility. The specifications for the switchgear must be observed.
10.12 Electromagnetic compatibility			
			Is the panel builder's responsibility. The specifications for the switchgear must be observed.
10.13 Mechanical function			
			The device meets the requirements, provided the information in the instruction leaflet (IL) is observed.

Technical data ETIM 7.0

Low-voltage industrial components (EG000017) / Thermal overload relay (EC000106)			
Electric engineering, automation, process control engineering / Low-voltage switch technology / Overload protection device / Thermal overload relay (ecl@ss10.0.1-27-37-15-01 [AKF075014])			
Adjustable current range		A	2.4 - 4
Max. rated operation voltage U_e		V	690
Mounting method			Direct attachment
Type of electrical connection of main circuit			Screw connection
Number of auxiliary contacts as normally closed contact			1
Number of auxiliary contacts as normally open contact			1
Number of auxiliary contacts as change-over contact			0
Release class			CLASS 10
Reset function input			No
Reset function automatic			Yes
Reset function push-button			Yes

Approvals

Product Standards			IEC/EN 60947-4-1; UL 60947-4-1; CSA - C22.2 No. 60947-4-1-14; CE marking
UL File No.			E29184

UL Category Control No.		NKCR
CSA File No.		12528
CSA Class No.		3211-03
North America Certification		UL listed, CSA certified
Specially designed for North America		No
Suitable for		Branch circuits
Max. Voltage Rating		600 V AC
Degree of Protection		IEC: IP20, UL/CSA Type: -

Characteristics

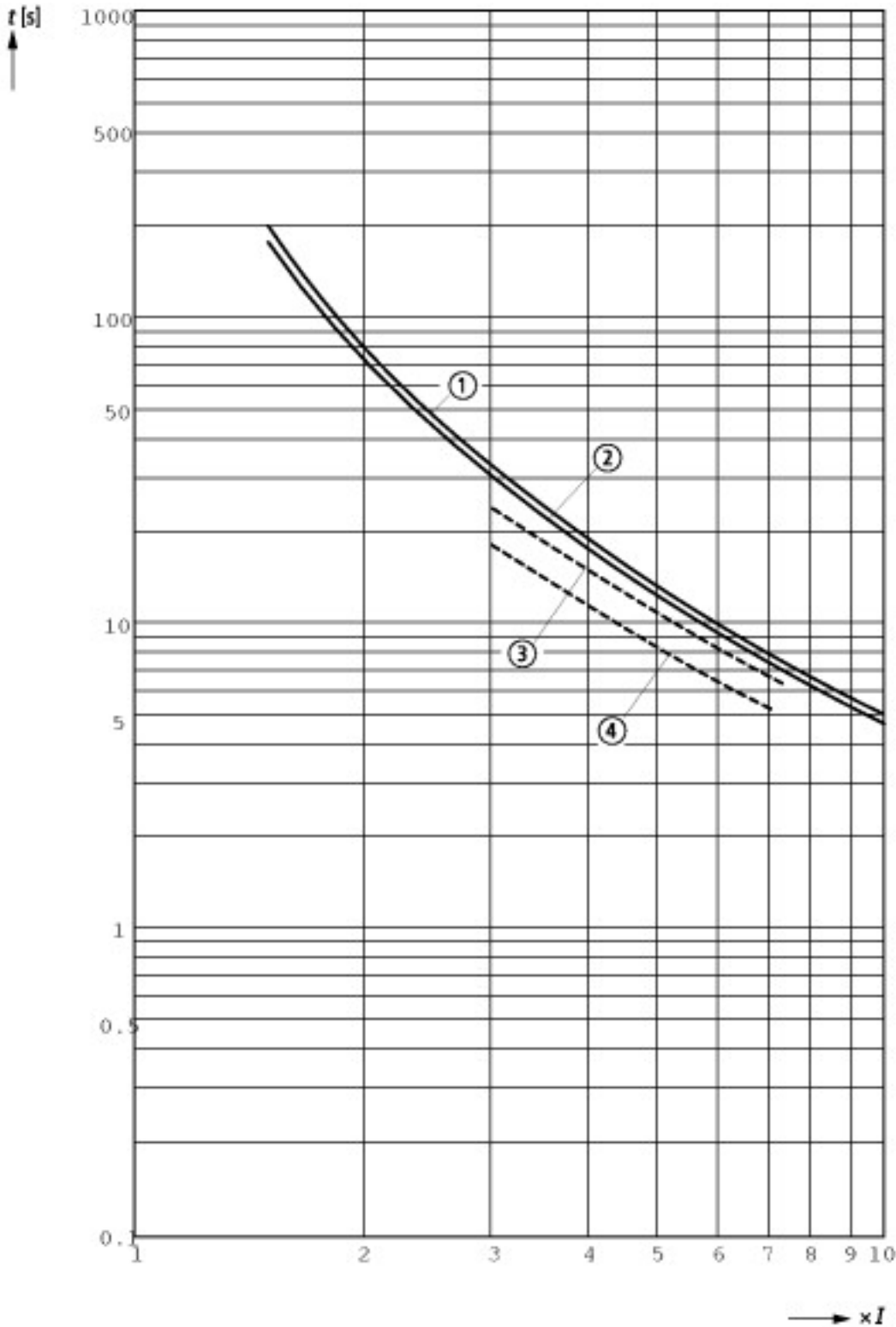

These tripping characteristics are mean values of the spreads at 20 °C ambient air temperature in a cold state.

Tripping time depends on response current.

When the devices are at operational temperature the tripping time of the overload relay falls to approx. 25 % of the read off value.

- 1: Minimum level, 3-phase
- 2: Maximum level, 3-phase
- 3: Minimum marker, 2-phase
- 4: Highest marker, 2-phase

Dimensions

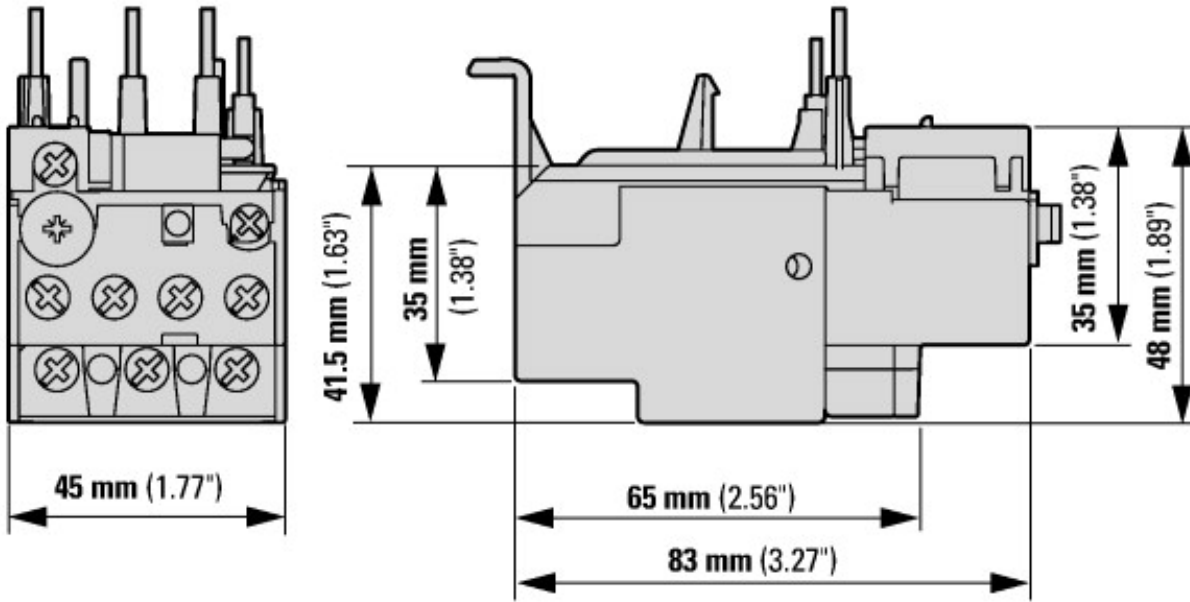

- ① OFF
- ② Reset/ON

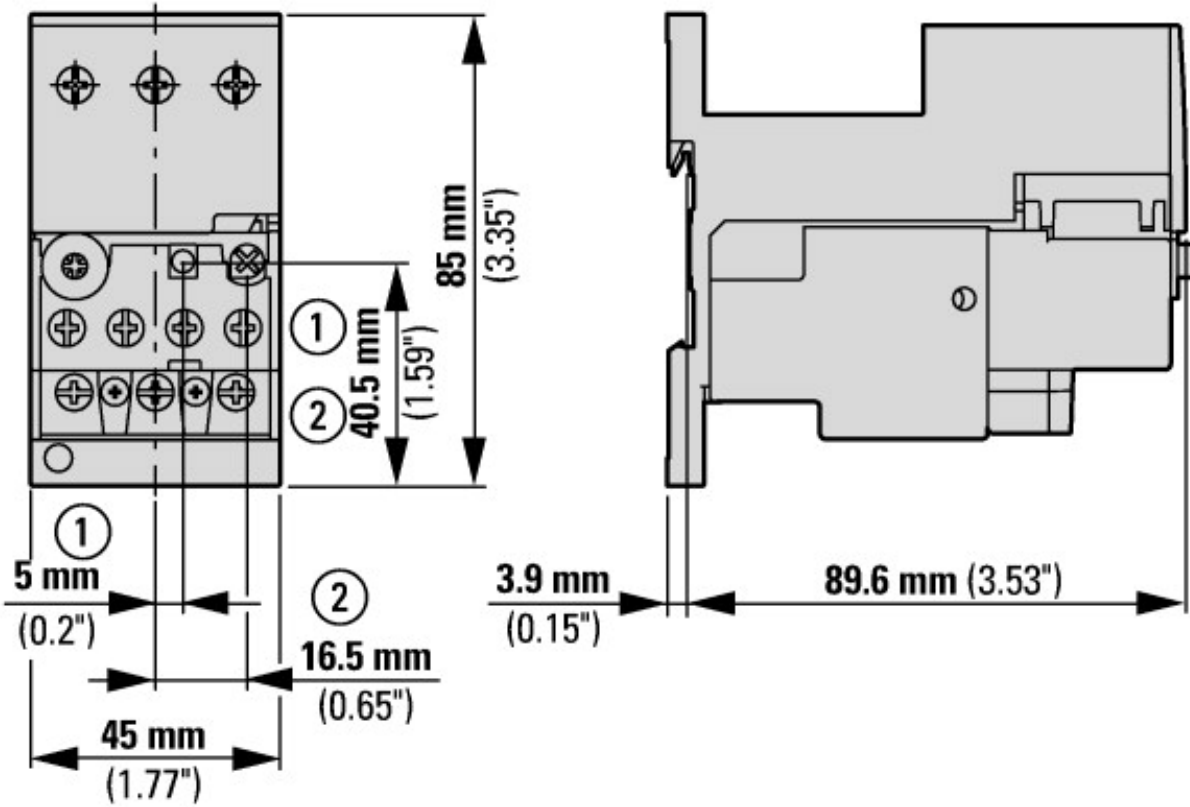

With base ZB32-XEZ



ZB32... + DILM

Assets (links)

Declaration of CE Conformity

00002848

Instruction Leaflets

IL03407015Z2018_04

Manuals

MN03407004Z_DE_EN (German)

MN03407004Z_DE_EN (English)

Additional product information (links)

IL03407015Z (AWA2300-2114) Overload relay

IL03407015Z (AWA2300-2114) Overload relay ftp://ftp.moeller.net/DOCUMENTATION/AWA_INSTRUCTIONS/IL03407015Z2018_04.pdf

IL03407195Z Sealable shroud

IL03407195Z Sealable shroud ftp://ftp.moeller.net/DOCUMENTATION/AWA_INSTRUCTIONS/IL03407195Z2018_06.pdf

MN03407004Z (AWB2300-1527D/GB) ZB12/XTOB...BC1 and ZB32/XTOB...CC1 overload relays, overload monitoring of Ex e motors

MN03407004Z (AWB2300-1527D/GB) ZB12/XTOB...BC1 and ZB32/XTOB...CC1 overload relays, overload monitoring of Ex e motors - Deutsch / English ftp://ftp.moeller.net/DOCUMENTATION/AWB_MANUALS/MN03407004Z_DE_EN.pdf