

Data sheet | Item number: 773-106

PUSH WIRE® connector for junction boxes; for solid and stranded conductors; max. 2.5 mm²; 6-conductor; transparent housing; violet cover; Surrounding air temperature: max 60°C

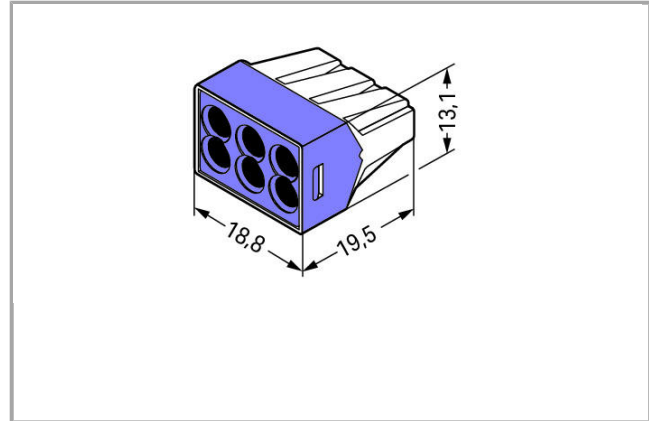

www.wago.com/773-106



Item description

Note:

Terminating Aluminum Conductors

WAGO spring clamp terminal blocks are suitable for solid aluminum conductors up to 4 mm²/12 AWG if WAGO "Alu-Plus" Contact Paste is used for termination.

"Alu-Plus" Contact Paste Advantages:

- Automatically destroys the oxide film during clamping.
- Prevents fresh oxidation at the clamping point.
- Prevents electrolytic corrosion between aluminum and copper conductors (in the same terminal block).
- Provides long-term protection against corrosion.

Using terminal blocks with PUSH WIRE® Spring Pressure Connection Technology, **aluminum conductors must first be cleaned with a blade and then immediately be inserted into the clamping units filled with "Alu-Plus" Contact Paste.**

It is also possible to apply WAGO "Alu-Plus" **additionally** on the whole surface of the aluminum conductor before termination.

Please note that the nominal currents must be adapted to the reduced conductivity of the aluminum conductors:

2.5 mm² (14 AWG) = 16 A4 mm² (12 AWG) = 22 A**Safety information 1:**

In grounded power lines

Safety information 2:When using conductors of exclusively the same cross section, 0.75 mm²/AWG 18 is also possible.**Data****Electrical data****Ratings per IEC/EN 60664-1**

Rated voltage (II / 2)	400 V
Rated impulse voltage (II / 2)	4 kV
Rated current	24 A

Connection data

Connection technology	PUSH WIRE®
Actuation type	Push-in
Connectable conductor materials	Copper Aluminum
Solid conductor	0.75 ... 2.5 mm ² / 18 ... 12 AWG
Stranded conductor	1.5 ... 2.5 mm ² / 16 ... 12 AWG
Strip length	12 mm / 0.47 inch
Total number of connection points	6
Total number of potentials	1
Type of wiring	Side-entry wiring
Leiterquerschnitte eindrätig	0.75 mm ²

Geometrical Data

Width	18.8 mm / 0.74 inch
Height	13.1 mm / 0.516 inch
Depth	19.5 mm / 0.768 inch

Material Data

Cover color	violet
Flammability class per UL94	V2
Weight	3.55 g

Environmental Requirements





Surrounding air (operating) temperature	60 °C
---	-------

Commercial data





Product Group	7 (Push Wire Conn.)
Country of origin	CN
GTIN	4044918397681

Approvals / Certificates



Country specific Approvals

Logo	Approval	Additional Approval Text	Certificate name
	CCA UL International Demko A/S	EN 60998	CCA-DK No. 2520
	CSA DEKRA Certification B.V.	C22.2	15411 (LR46759)
	KEMA/KEUR DEKRA Certification B.V.	EN 60998	71- 101747
	ÖVE Österreichischer Verband für Elektrotechnik	EN 60998	1193-031- 09

Ship Approvals

Logo	Approval	Additional Approval Text	Certificate name
	ABS American Bureau of Shipping	-	18- HG1755093- PDA
	BV Bureau Veritas S.A.	EN 60998	11914/C0 BV
	DNV GL Det Norske Veritas, Germanischer Lloyd	EN 60998	TAE000015T
	LR Lloyds Register	EN 60998	04/20013 (E8)

UL-Approvals

Logo	Approval	Additional Approval Text	Certificate name
	UL UL International Germany GmbH	UL 486C	E69654
	UL UL International Germany GmbH	EN 60998	D-03479-A1

Compatible products

Mounting adapter



Item no.: 773-332

Mounting carrier; 773 Series - 2.5 mm² / 4 mm² / 6 mm²; for DIN-35 rail mounting/screw mounting

www.wago.com/773-332

General accessories



Item no.: 249-130

Syringe; Contents: 20 ml Alu-Plus contact paste

www.wago.com/249-130

Downloads

Documentation

Additional Information

Technical explanations

Apr 3, 2019

pdf
2.1 MB

Download

CAD/CAE - Smart Data

WSCAD

WSCAD Universe

Download

Subject to changes.