

Data sheet | Item number: 773-332

Mounting carrier; 773 Series - 2.5 mm² / 4 mm² / 6 mm²; for DIN-35 rail mounting/screw mounting; orange

www.wago.com/773-332

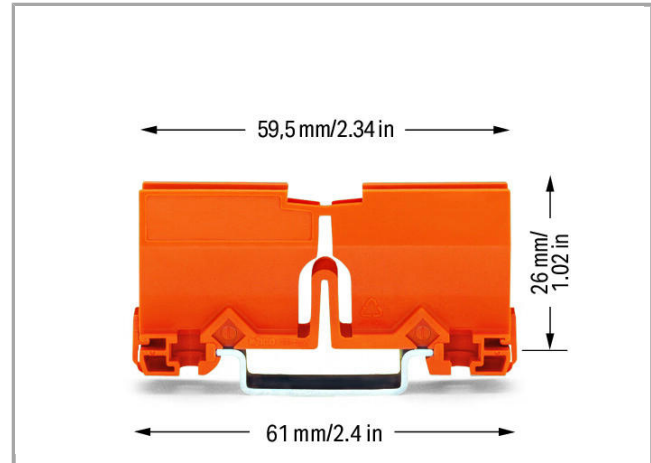
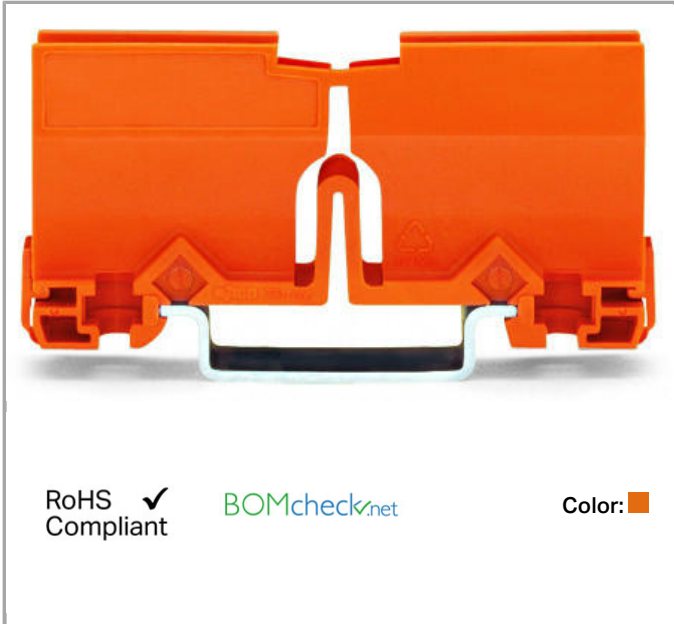

Data

Geometrical Data

Width	18 mm / 0.709 inch
Height	26 mm / 1.024 inch
Depth	61 mm / 2.402 inch

Material Data

Color	orange
Fire load	0.255 MJ
Weight	8.5 g

Commercial data

Product Group	7 (Push Wire Conn.)
Country of origin	DE
GTIN	4044918526524

Compatible products

















Marking accessories



Item no.: 210-834
Marking strips; on reel; 5 mm wide; plain; Self-adhesive; white

www.wago.com/210-834

General accessories

	Item no.: 773-102 PUSH WIRE® connector for junction boxes; for solid and stranded conductors; max. 2.5 mm ² ; 2-conductor; transparent housing; yellow cover; Surrounding air temperature: max 60°C; 2,50 mm ²	www.wago.com/773-102
	Item no.: 773-104 PUSH WIRE® connector for junction boxes; for solid and stranded conductors; max. 2.5 mm ² ; 4-conductor; transparent housing; orange cover; Surrounding air temperature: max 60°C; 2,50 mm ²	www.wago.com/773-104
	Item no.: 773-106 PUSH WIRE® connector for junction boxes; for solid and stranded conductors; max. 2.5 mm ² ; 6-conductor; transparent housing; violet cover; Surrounding air temperature: max 60°C; 2,50 mm ²	www.wago.com/773-106
	Item no.: 773-108 PUSH WIRE® connector for junction boxes; for solid and stranded conductors; max. 2.5 mm ² ; 8-conductor; transparent housing; dark gray cover; Surrounding air temperature: max 60°C; 2,50 mm ²	www.wago.com/773-108
	Item no.: 773-112 PUSH WIRE® connector for junction boxes; for solid and stranded conductors; max. 2.5 mm ² ; 2-conductor; transparent housing; green cover; Surrounding air temperature: max 60°C; 2,50 mm ²	www.wago.com/773-112
	Item no.: 773-114 PUSH WIRE® connector for junction boxes; for solid and stranded conductors; max. 2.5 mm ² ; 4-conductor; transparent housing; green cover; Surrounding air temperature: max 60°C; 2,50 mm ²	www.wago.com/773-114
	Item no.: 773-116 PUSH WIRE® connector for junction boxes; for solid and stranded conductors; max. 2.5 mm ² ; 6-conductor; transparent housing; green cover; Surrounding air temperature: max 60°C; 2,50 mm ²	www.wago.com/773-116
	Item no.: 773-118 PUSH WIRE® connector for junction boxes; for solid and stranded conductors; max. 2.5 mm ² ; 8-conductor; transparent housing; green cover; Surrounding air temperature: max 60°C; 2,50 mm ²	www.wago.com/773-118
	Item no.: 773-124 PUSH WIRE® connector for junction boxes; for solid and stranded conductors; max. 2.5 mm ² ; 4-conductor; transparent housing; light gray cover; Surrounding air temperature: max 60°C; 2,50 mm ²	www.wago.com/773-124
	Item no.: 773-162 PUSH WIRE® connector for junction boxes; for solid and stranded conductors; max. 2.5 mm ² ; 2-conductor; transparent housing; yellow cover; Surrounding air temperature: max 60°C; 2,50 mm ²	www.wago.com/773-162
	Item no.: 773-164 PUSH WIRE® connector for junction boxes; for solid and stranded conductors; max. 2.5 mm ² ; 4-conductor; transparent housing; orange cover; max. ambient operating temp. 60 °C; 2,50 mm ²	www.wago.com/773-164
	Item no.: 773-173 PUSH WIRE® connector for junction boxes; for solid and stranded conductors; max. 6 mm ² ; 3-conductor; transparent housing; red cover; Surrounding air temperature: max 60°C; 6,00 mm ²	www.wago.com/773-173
	Item no.: 773-514 PUSH WIRE® connector for junction boxes; for solid and stranded conductors; max. 2.5 mm ² ; 4-conductor; Black housing; black cover; Max. surrounding air temperature: 105 °C; 2,50 mm ²	www.wago.com/773-514
	Item no.: 773-602 PUSH WIRE® connector for junction boxes; for solid conductors; max. 4 mm ² ; 2-conductor; Brown clear housing; white cover; Surrounding air temperature: max 60°C; 2,50 mm ²	www.wago.com/773-602
	Item no.: 773-604 PUSH WIRE® connector for junction boxes; for solid conductors; max. 4 mm ² ; 4-conductor; Brown clear housing; red cover; Surrounding air temperature: max 60°C; 2,50 mm ²	www.wago.com/773-604
	Item no.: 773-606 PUSH WIRE® connector for junction boxes; for solid conductors; max. 4 mm ² ; 6-conductor; Brown clear housing; brown cover; Surrounding air temperature: max 60°C; 2,50 mm ²	www.wago.com/773-606



Downloads

Documentation

Additional Information

Technical explanations	Apr 3, 2019	pdf 2.1 MB	Download
------------------------	-------------	---------------	----------

CAD/CAE - Smart Data

CAD data

3D Download 773-332	URL	Download
---------------------	-----	----------

EPLAN

EPLAN Data Portal	Download
-------------------	----------

WSCAD

WSCAD Universe	Download
----------------	----------

Subject to changes.