

Betaduct LFH Noryl Closed Slot Cable Trunking

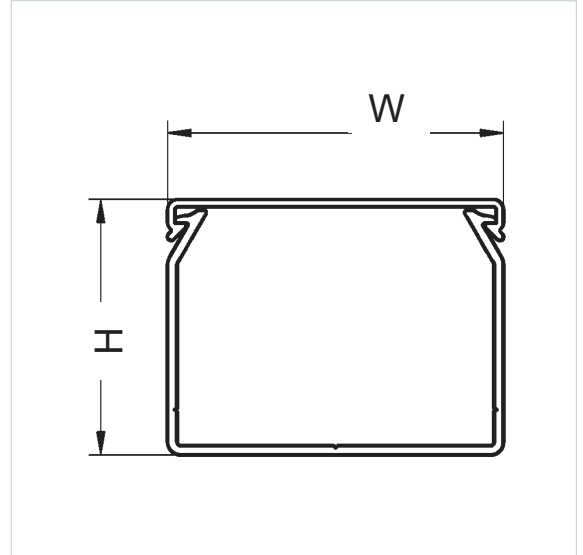

Specificatio

Material	Noryl NH6010B Resin
Colour	Black RAL9004
Operating Temp	-25°C to +120°C
Volume Resistivity	7.6E+17 Ohm. cm
Dielectric Strength	34 kV/mm
Flame Resistance	UL94 V0
Yield Stress	64 MPa
LOI	33%
Toxicity Rating	NF F16-101
M1 Flame Rating	NF P 92501
Glow Wire Flammability	+960°C
Lateral Flame Spread	20.0 kW/m ²
London Underground	Product Registration No. 1107

Key Features

- Lightweight and self-extinguishing
- LSOH
- Excellent rigidity and performance characteristics
- Easy installation
- Base holes to DIN 43659
- Break points on finger
- Secure clip on lid
- Supplied in 2m lengths









Spare lids available



Part Number	Nominal External (mm)		Lengths Per Pack	Quantity Per Pack (m)
	Height	Width		
23451000N	37.5	25	12	24
23452000N	50	25	12	24
23453000N	75	25	8	16
23454000N	50	50	8	16
23455000N	75	50	8	16
23456000N	75	75	8	16

Betaduct LFH Noryl Closed Slot Cable Trunking

You might also need...

<p>EDC1</p>  <p>Betaduct Trunking Cutting Tool</p> <ul style="list-style-type: none">• Blade W: 21.5mm• Cutting D: 50mm	<p>BETADUCT-CUTTER</p>  <p>Betaduct Trunking Cutting Tool</p> <ul style="list-style-type: none">• Cuts up to 125mm	<p>EDC 2</p>  <p>Betaduct Trunking Cutting Tool</p> <ul style="list-style-type: none">• Cuts up to 110mm	<p>1857</p>  <p>Betaduct Trunking Cutting Tool</p> <ul style="list-style-type: none">• Ideal for cutting slots in trunking	<p>RT4 or RT6</p>  <p>Betaduct Trunking Rivet Tools</p> <ul style="list-style-type: none">• 4.5mm (RT4)• 6.5mm (RT6)	<p>DUCTAFIX R4 or R6</p>  <p>Betaduct Trunking Rivets</p> <ul style="list-style-type: none">• 4mm (R4)• 6mm (R6)
<p>10440000</p>  <p>Betaduct Insulating Washers</p> <ul style="list-style-type: none">• Black• Pack of 50	<p>BC1</p>  <p>HF Bridging Clip For Narrow Trunking</p> <ul style="list-style-type: none">• 22.5mm x 105mm• Pack of 50	<p>BC2</p>  <p>HF Bridging Clip For Narrow Trunking</p> <ul style="list-style-type: none">• 24mm x 108mm• Pack of 50			

Betaduct LFH Noryl Closed Slot Cable Trunking

H = 25 mm
 H = 37.5 mm
 H = 50 mm

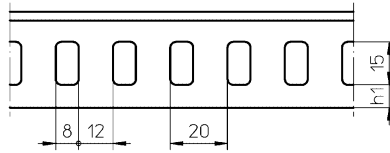
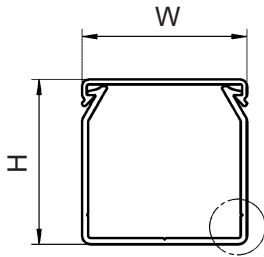

W = 25, 37.5, and 50 mm

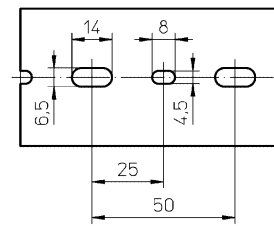

H = 75 mm

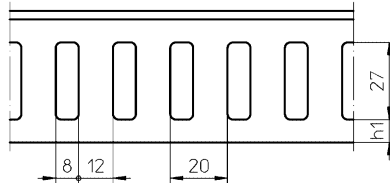
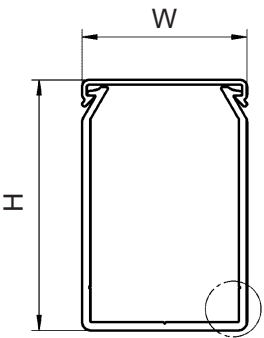

W = 75, 100 and 125mm

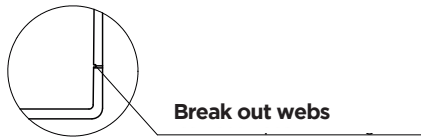
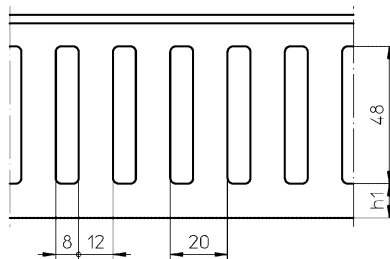
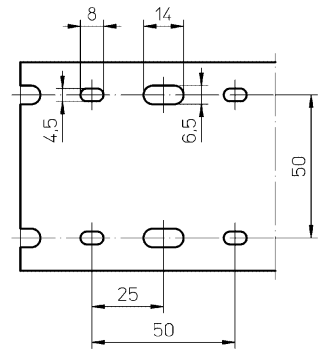

Base punching to DIN 43659

H (mm)	25	37.5	50	75
h1 (mm)	6	8	8	12

Betaduct Trunking Capacity Chart

Trunking Nominal External Width x Height (mm)	Internal Cross Sectional Area (mm ²)	At 50% Packing Density (mm ²)	Cable Cross Sectional Area (mm ²) Tri-Rated Cable BS6231															
			Cable Diameter (mm)															
			0.50	0.75	1.00	1.50	2.50	4.00	6.00	10.00	16.00	25.00	35.00	50.00	70.00	95.00		
25 x 37.5	608	304	55	48	43	35	28	19	16	9	4	3	2	1	1	1	1	
25 x 50	836	418	76	66	59	48	38	27	22	12	6	4	3	2	1	1	1	
25 x 75	1311	655.5	120	104	92	76	60	43	34	19	10	7	5	3	3	2	2	
37.5 x 37.5	1024	512	94	81	72	59	47	33	27	15	7	5	4	2	2	1	1	
37.5 x 50	1408	704	129	111	99	82	65	46	37	21	10	8	6	4	3	2	2	
37.5 x 75	2208	1104	203	175	156	129	102	72	58	33	17	12	9	6	5	3	3	
50 x 37.5	1408	704	129	111	99	82	65	46	37	21	10	8	6	4	3	2	2	
50 x 50	1936	968	178	153	136	113	90	63	51	29	15	11	8	5	4	3	3	
50 x 75	3036	1518	279	241	214	177	141	99	80	45	23	17	13	8	7	5	5	
50 x 100	4136	2068	380	328	292	241	192	136	109	62	32	23	18	12	9	7	7	
75 x 37.5	2208	1104	203	175	156	129	102	72	58	33	17	12	9	6	5	3	3	
75 x 50	3036	1518	279	241	214	177	141	99	80	45	23	17	13	8	7	5	5	
75 x 75	4761	2380.5	438	378	336	278	221	156	126	71	37	27	21	13	11	8	8	
75 x 100	6486	3243	596	515	458	379	301	213	171	97	50	37	29	18	15	11	11	
100 x 50	4136	2068	380	328	292	241	192	136	109	62	32	23	18	12	9	7	7	
100 x 75	6486	3243	596	515	458	379	301	213	171	97	50	37	29	18	15	11	11	
100 x 100	8836	4418	813	702	625	516	410	290	234	133	68	50	39	25	20	16	16	
150 x 100	13536	6768	1245	1075	957	791	629	445	358	203	105	77	60	39	31	24	24	
125 x 75	8142	4071	749	647	575	475	378	267	215	122	63	46	36	23	18	14	14	