

ZB5AT84

Emergency stop head, switching off, plastic, red mushroom Ø40, Ø22, trigger latching push-pull



Main

| | |
|-------------------------------|--|
| Range of product | Harmony XB5 |
| Product or component type | Head |
| Product destination | Emergency stop push-button |
| Device short name | ZB5 |
| Bezel material | Dark grey plastic |
| Head type | Standard |
| Mounting diameter | 22 mm |
| Sale per indivisible quantity | 1 |
| Shape of signaling unit head | Round |
| Type of operator | Trigger action and mechanical latching |
| Reset | Push-pull |
| Operator profile | Red mushroom Ø 40 mm, unmarked |
| Device presentation | Basic element |

Complementary

| | |
|-----------------------------|--|
| CAD overall width | 40 mm |
| CAD overall height | 40 mm |
| CAD overall depth | 56 mm |
| Net weight | 0.05 kg |
| Mechanical durability | 300000 cycles |
| Station name | XALD 1 cut-out XALK 1 cut-out |
| Electrical composition code | C7 for <4 contacts using single blocks in front mounting C8 for <4 contacts using single and double blocks in front mounting C11 for <3 contacts using single blocks in front mounting C15 for <1 contacts using single blocks in front mounting SF1 for <3 contacts using single blocks in front mounting SR1 for <3 contacts using single blocks in rear mounting C10 for <4 contacts using single and double blocks in front mounting |

Environment

| | |
|---------------------------------------|---|
| Protective treatment | TH |
| Ambient air temperature for storage | -40...70 °C |
| Ambient air temperature for operation | -40...70 °C |
| Overvoltage category | Class II conforming to IEC 60536 |
| IP degree of protection | IP66 conforming to IEC 60529 IP67 IP69 IP69K |
| NEMA degree of protection | NEMA 13 NEMA 4X |
| Resistance to high pressure washer | 7000000 Pa at 55 °C, distance : 0.1 m |
| IK degree of protection | IK03 conforming to IEC 50102 |

| | |
|------------------------|---|
| Standards | EN/ISO 13850 EN/IEC 60947-5-1 CSA C22.2 No 14 IEC 60364-5-53 JIS C8201-5-1 UL 508 EN/IEC 60947-1 GB 14048.5 EN/IEC 60947-5-4 EN/IEC 60947-5-5 EN/IEC 60204-1 JIS C8201-1 |
| Product certifications | LROS (Lloyds register of shipping) RINA BV DNV UL listed GL CSA |
| Vibration resistance | 5 gn (f= 2...500 Hz) conforming to IEC 60068-2-6 |
| Shock resistance | 30 gn (duration = 18 ms) for half sine wave acceleration conforming to IEC 60068-2-27 50 gn (duration = 11 ms) for half sine wave acceleration conforming to IEC 60068-2-27 |

Offer Sustainability

| | |
|----------------------------|--|
| Sustainable offer status | Green Premium product |
| REACH Regulation | REACH Declaration |
| REACH free of SVHC | Yes |
| EU RoHS Directive | Pro-active compliance (Product out of EU RoHS legal scope) EU RoHS Declaration |
| Toxic heavy metal free | Yes |
| Mercury free | Yes |
| RoHS exemption information | Yes |
| China RoHS Regulation | China RoHS Declaration |
| Environmental Disclosure | Product Environmental Profile |
| Circularity Profile | End Of Life Information |

Contractual warranty

| | |
|----------|-----------|
| Warranty | 18 months |
|----------|-----------|

Dimensions

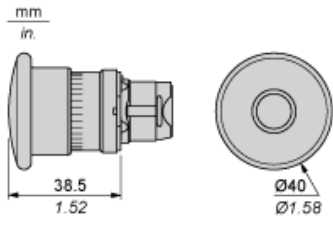

Panel Cut-out for Pushbuttons, Switches and Pilot Lights (Finished Holes, Ready for Installation)

Connection by Screw Clamp Terminals or Plug-in Connectors or on Printed Circuit Board

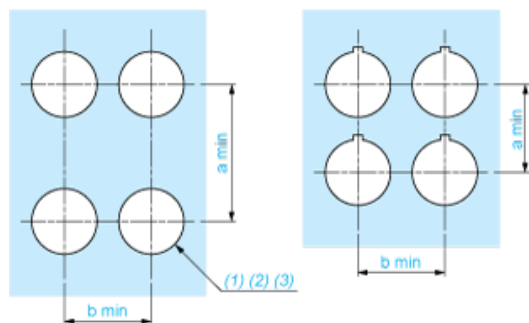

- (1) Diameter on finished panel or support
- (2) For selector switches and Emergency stop buttons, use of an anti-rotation plate type ZB5AZ902 is recommended.
- (3) $\varnothing 22.5$ mm recommended ($\varnothing 22.3 \text{ }_0^{+0.4}$) / $\varnothing 0.89$ in. recommended ($\varnothing 0.88 \text{ in. }_0^{+0.016}$)

| Connections | a in mm | a in in. | b in mm | b in in. |
|---|---------|----------|---------|----------|
| By screw clamp terminals or plug-in connector | 40 | 1.57 | 30 | 1.18 |
| By Faston connectors | 45 | 1.77 | 32 | 1.26 |
| On printed circuit board | 30 | 1.18 | 30 | 1.18 |

Detail of Lug Recess



- (1) Diameter on finished panel or support
- (2) For selector switches and Emergency stop buttons, use of an anti-rotation plate type ZB5AZ902 is recommended.
- (3) $\varnothing 22.5$ mm recommended ($\varnothing 22.3 \text{ }_0^{+0.4}$) / $\varnothing 0.89$ in. recommended ($\varnothing 0.88 \text{ in. }_0^{+0.016}$)

Pushbuttons, Switches and Pilot Lights for Printed Circuit Board Connection

Panel Cut-outs (Viewed from Installer's Side)



- A: 30 mm min. / 1.18 in. min.
- B: 40 mm min. / 1.57 in. min.

Printed Circuit Board Cut-outs (Viewed from Electrical Block Side)

Dimensions in mm



- A: 30 mm min.
- B: 40 mm min.

Dimensions in in.

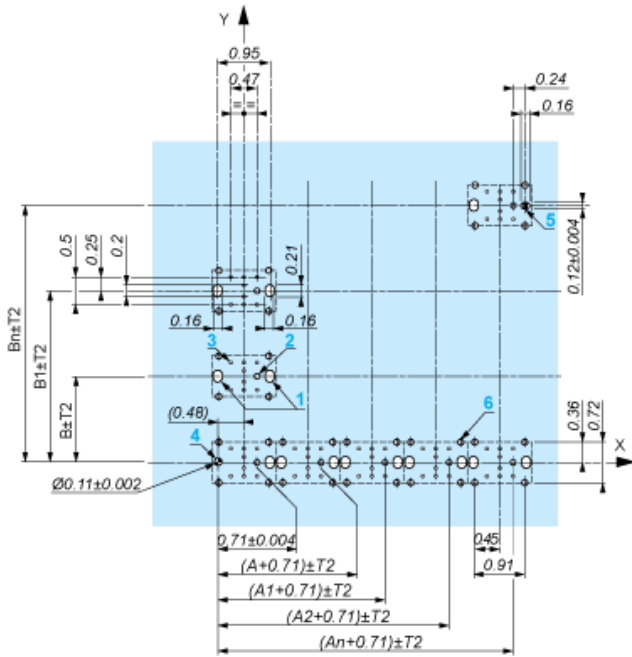

- A: 1.18 in. min.
- B: 1.57 in. min.

General Tolerances of the Panel and Printed Circuit Board

The cumulative tolerance must not exceed 0.3 mm / 0.012 in.: T1 + T2 = 0.3 mm max.

Installation Precautions

- Minimum thickness of circuit board: 1.6 mm / 0.06 in.
- Cut-out diameter: 22.4 mm ± 0.1 / 0.88 in. ± 0.004
- Orientation of body/fixing collar ZB5AZ009: ± 2°30' (excluding cut-outs marked a and b).
- Tightening torque of screws ZBZ006: 0.6 N.m (5.3 lbf.in) max.
- Allow for one ZB5AZ079 fixing collar/pillar and its fixing screws:
 - every 90 mm / 3.54 in. horizontally (X), and 120 mm / 4.72 in. vertically (Y).
 - with each selector switch head (ZB5AD•, ZB5AJ•, ZB5AG•).

The fixing centers marked a and b are diagonally opposed and must align with those marked 4 and 5.

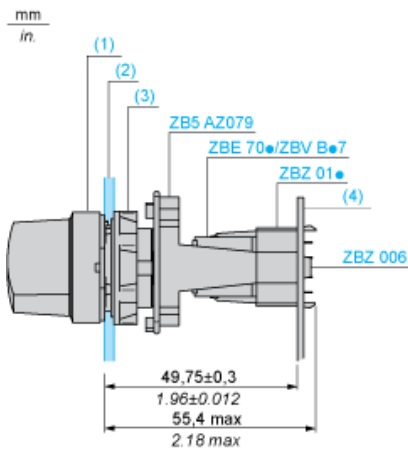

- (1) Head ZB5AD•
- (2) Panel
- (2) Nut
- (4) Printed circuit board

Mounting of Adapter (Socket) ZBZ01•

- 1 2 elongated holes for ZBZ006 screw access
- 2 1 hole $\varnothing 2.4 \text{ mm} \pm 0.05 / 0.09 \text{ in.} \pm 0.002$ for centring adapter ZBZ01•
- 3 8 $\times \varnothing 1.2 \text{ mm} / 0.05 \text{ in.}$ holes
- 4 1 hole $\varnothing 2.9 \text{ mm} \pm 0.05 / 0.11 \text{ in.} \pm 0.002$, for aligning the printed circuit board (with cut-out marked a)
- 5 1 elongated hole for aligning the printed circuit board (with cut-out marked b)
- 6 4 holes $\varnothing 2.4 \text{ mm} / 0.09 \text{ in.}$ for clipping in adapter ZBZ01•

Dimensions An + 18.1 relate to the $\varnothing 2.4 \text{ mm} \pm 0.05 / 0.09 \text{ in.} \pm 0.002$ holes for centring adapter ZBZ01•.

Electrical Composition Corresponding to Code C7



Electrical Compositions Corresponding to Code C8

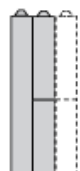

Electrical Compositions Corresponding to Code C10

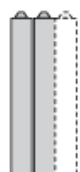

Electrical Composition Corresponding to Codes C9, C11, SF1 and SR1



Electrical Composition Corresponding to Code C15

1 N/O

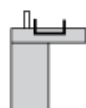

1 N/C



1 N/O + N/C or 1 N/O + N/O or 1 N/C + N/C

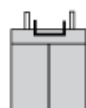

Legend

Single contact



Double contact



Light block



Possible location

