

ø22 Switches & Pilot Lights

TW Series







General-purpose switches & pilot lights for various applications.
Heavy-duty type for high-level protection against harsh environment.







- DC-DC converter types are not approved by standards.
- See website for details on approvals and standards.





TW Series Selection Guide

Function	Pushbutton				
Category	Flush	Extended	Extended w/Full Shroud	ø29mm Mushroom	ø40mm Mushroom
	Momentary/Maintained	Momentary/Maintained	Momentary/Maintained	Momentary/Maintained	Momentary/Maintained
Shape					
Model	ABW1 AOW1	ABW2 AOW2	ABFW2 AOFW2	ABW3 AOW3	ABW4 AOW4
Page	B-238	B-238	B-238	B-238	B-239

Function	Pushbutton				
Category	ø40mm Mushroom w/Full Shroud	ø29mm Mushroom Pushlock Turn Reset	ø40mm Mushroom Pushlock Turn Reset	ø40mm Mushroom Push Turn Lock	ø29mm Mushroom Pushlock Key Reset
	Momentary				
Shape					
Model	ABGW4	AVW3	AVW4	AJW4	AXW3
Page	B-239	B-239	B-239	B-239	B-239

Function	Pushbutton			
Category	ø40mm Mushroom Pushlock Key Reset	ø40mm Mushroom Push Pull	Square Flush	Square Extended
			Momentary/Maintained	Momentary/Maintained
Shape				
Model	AXW4	AYW4	ABQW1 AOQW1	ABQW2 AOQW2
Page	B-240	B-240	B-240	B-240

Function	Pilot Light		
Category	Flush (Non-marking/Marking)	Dome	Square Flush (Marking)
	Shape		
Model	APW1 APW1B	APW2	APQW1B
Page	B-241	B-241	B-241

APEM

Switches & Pilot Lights

Control Boxes

Emergency Stop Switches

Enabling Switches

Safety Products

Explosion Proof

Terminal Blocks

Relays & Sockets

Circuit Protectors

Power Supplies

LED Illumination

Controllers

Operator Interfaces

Sensors

AUTO-ID

Flush Silhouette

ø16

ø22

ø30

Miniature

Pilot Lights

HW





TW

YW

Download catalogs and CAD from <http://eu.idec.com/downloads>

B-230

TW Series Selection Guide

Function	Illuminated Pushbutton				
	Extended (Non-marking/Marking)	Extended w/Full Shroud (Non-marking/Marking)	Square Extended (Marking)	ø29mm Mushroom Pushlock Turn Reset (Non-marking/Marking)	ø40mm Mushroom Pushlock Turn Reset (Non-marking/Marking)
Category	Momentary/Maintained	Momentary/Maintained	Momentary/Maintained		
Shape					
Part No.	ALW2, ALW2B, AOLW2, AOLW2B	ALFW2, AOLFW2 ALFW2B, AOLFW2B	ALQW2B AOLQW2B	AVLW3 AVLW3B	AVLW4 AVLW4B
Page	B-243	B-244	B-245	B-246	B-246

Function	Selector Switch			Illuminated Selector Switch
	Knob	Lever	Key	
Category	Knob	Lever	Key	Knob
Shape				
Part No.	ASW	ASW□L	ASW□K	ASLW
Page	B-249	B-250	B-251	B-252

ø22 TW Series Switches & Pilot Lights

General-purpose switches & pilot lights for various applications.
Heavy-duty type for high-level protection against harsh environment.

- Easy wiring for crimping terminal.
- UL, CSA, TÜV, CCC compliant.



APEM

Switches & Pilot Lights

Control Boxes

Emergency Stop Switches

Enabling Switches

Safety Products

Explosion Proof

Terminal Blocks

Relays & Sockets

Circuit Protectors

Power Supplies

LED Illumination

Controllers

Operator Interfaces

Sensors

AUTO-ID

Flush Silhouette

ø16

ø22

ø30

Miniature

Pilot Lights

HW

TW

YW

Specifications and Ratings

Contact Ratings

Pushbuttons Illuminated Pushbuttons Selector Switches Illuminated Selector Switches	Rated insulation voltage	600V
	Rated continuous current	10A
	Contact ratings by utilization category IEC60947-5-1	AC-15 (A600) DC-13

Contact Ratings by Utilization Category

HW-U10 (NO contact), HW-U01 (NC contact)

Operating Voltage			24V	48V	50V	110V	220V	440V
Operating Current	AC 50/60 Hz	AC-12 Control of resistive loads and solid state loads	10A	—	10A	10A	6A	2A
		AC-15 Control of electromagnetic loads (> 72 VA)	10A	—	7A	5A	3A	1A
	DC	DC-12 Control of resistive loads and solid state loads	10A	5A	—	2.2A	1.1A	—
		DC-13 Control of electromagnets	5A	2A	—	1.1A	0.6A	—

HW-U10R (EM contact/NO contact), HW-U01R (LB contact/NC contact)

Operating Voltage			24V	48V	50V	110V	220V	440V
Operating Current	AC 50/60 Hz	AC-12 Control of resistive loads and solid state loads	5A	—	5A	5A	3A	1A
		AC-15 Control of electromagnetic loads (> 72 VA)	5A	—	3.5A	2.5A	1.5A	0.5A
	DC	DC-12 Control of resistive loads and solid state loads	5A	2.5A	—	1.1A	0.55A	—
		DC-13 Control of electromagnets	2.5A	1A	—	0.55A	0.3A	—

- The operating current represents the classification by making and breaking currents (IEC 60947-5-1).
- Contact materials: Silver contacts
- Minimum applicable load: 3V AC/DC, 5 mA (applicable range may vary with operating conditions and load types)

HW-U Contact Block

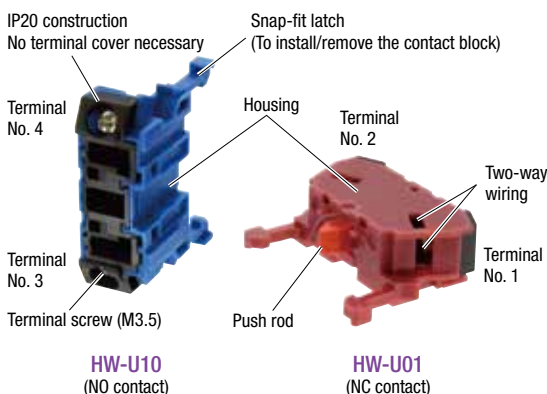

Part No.	HW-U10	HW-U01	HW-U10R	HW-U01R
Contact				
Contact No.	1NO	1NC	EM (NO) (early make)	LB (NC) (late break)
Contact No.	3-4	1-2	3-4	1-2
Housing	Blue	Purple red	Blue	Purple red
Push Rod	Green	Red	Black	White
Weight	Approx. 11g			

- Up to 2 layers (4 blocks) can be attached. AYW: 2 blocks (1 layer) maximum.
- Gold contacts available (gold-plated silver)



Download catalogs and CAD from <http://eu.idec.com/downloads>

ø22 TW Series Switches & Pilot Lights

LED Specifications

Unit	Color	Rated Voltage		Operating Voltage		LED lamp		
						Lamp Base	Part No.	
Pilot light Illuminated pushbutton Illuminated selector switch	R (red) G (green) Y (yellow) A (amber) S (blue) PW (pure white)	6V AC/DC		6V AC/DC		BA9S/13	LSTD-6*	
		12V AC/DC		12V AC/DC			LSTD-1*	
		24V AC/DC		24V AC/DC			LSTD-2*	
		100/110V AC		50/60 Hz	100/110V AC		LSTD-6*	
		115/120V AC			115/120V AC			
		200/220V AC			200/220V AC			
		230/240V AC			230/240V AC			
		380V AC			380V AC			
		400/440V AC			400/440V AC			
		480V AC			480V AC			
		110V DC			90 to 140V DC			
				±10%				

• See below for details on LED lamp ratings.





• Color codes for units without LED lamps:

R (red), G (green), A (amber), Y (yellow), S (blue)

When using a commercially available lamp, choose a lamp with rated voltage 5 to 30V AC/DC and 1W maximum, and with the same base and shape.



Make sure of correct operation before installation. The operation of TW series cannot be guaranteed when a commercially available lamp is used.

Power Unit Terminal

Power Unit	Illuminated Unit			Pilot Light
	Full voltage adapter	Transformer		DC-DC converter
Rated Voltage	6, 12, 24V AC/DC	100 to 240V AC	380V AC minimum	110V DC
Polarity	None	None	None	X1 (+) X2 (-)
Shape/Terminal				

LED Lamp Ratings

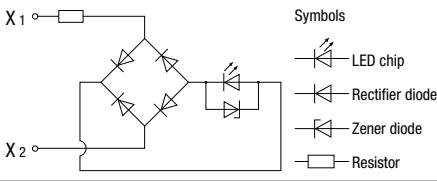
LSTD

Part No.	LSTD-6*			LSTD-1*		LSTD-2*		
Lamp Base	BA9S/13							
Rated Voltage	6V AC/DC			12V AC/DC		24V AC/DC		
Voltage Range	6V AC/DC ±10%			12V AC/DC ±10%		24V AC/DC ±10%		
Current Draw	Color	R, A	G, PW	S	R, G, A, PW	S	R, G, A, PW	S
	DC	7mA	5.5mA	4.5mA	10mA	8mA	10mA	8mA
	AC	8mA	8mA	7mA	11mA	9mA	11mA	9mA
Lamp Base Color	Same as illumination color (PW: gray)							
Voltage Marking	Die stamped on the base							
Life (reference value)	Approx. 50,000 hours (The luminance is reduced to 50% the initial intensity when used on complete DC at 25°C.)							
Internal Circuit	 <p>Symbols</p> <ul style="list-style-type: none"> LED chip Rectifier diode Zener diode Resistor <p>Example: LSTD-2PW</p> 							
Weight	Approx. 2g							

• Specify a color code in place of *. R (red), G (green), A (amber), S (blue), PW (pure white)

• Use a pure white (PW) LED for yellow (Y) illumination.

Specifications

Operating Temperature		-25 to +50°C (no freezing)	
Operating Humidity		45 to 85% RH (no condensation)	
Storage Temperature		-40 to +80°C (no freezing)	
Contact Resistance		50 mΩ maximum (initial value)	
Insulation Resistance		100 MΩ minimum (500V DC megger)	
Dielectric Strength		Between live and dead metal parts: 2,500V AC, 1 minute (Full voltage and illuminated units: 2,000V AC, 1 minute)	
Vibration Resistance	Operating extremes	5 to 55 Hz, amplitude 0.5 mm	
	Damage limits	30 Hz, amplitude 1.5 mm	
Shock Resistance	Operating extremes	100m/s ²	
	Damage limits	1,000m/s ² (*5)	
Mechanical Life (minimum operations)	Pushbutton	Momentary	5,000,000
		Maintained	500,000 (3 contact blocks and over: 250,000)
		Push-to-lock, Turn-to-reset	500,000
		Other	500,000
	Illuminated pushbutton	Momentary	5,000,000
		Maintained	500,000 (3 contact blocks and over: 250,000)
		Push-to-lock, Turn-to-reset	500,000
	Selector switch	500,000	
	Key selector switch	500,000	
	Illuminated selector switch	500,000	
Electrical Life (*4) (minimum operations)	Pushbutton	Momentary	500,000 (*1)
		Maintained	500,000 (3 contact blocks and over: 250,000) (*3)
		Push-to-lock, Turn-to-reset	500,000 (*3)
		Other	500,000
	Illuminated pushbutton	Momentary	500,000 (*1)
		Maintained	500,000 (3 contact blocks and over: 250,000) (*3)
		Push-to-lock, Turn-to-reset	500,000 (*3)
	Selector switch	500,000 (*2)	
	Key selector switch	500,000 (*2)	
	Illuminated selector switch	250,000 (*2)	
Weight (Apporox.)		68g (ABW122) 33g (APW122D) 89g (ALW22222D) 68g (ASW222) 107g (ASW2K22) 90g (ASLW22222D) 95g (APW126D)	

*1) Switching frequency 1,800 operations/h, duty ratio 40%
 *2) Switching frequency 1,200 operations/h, duty ratio 40%
 *3) Switching frequency 900 operations/h, duty ratio 40%
 *4) Load condition 220V AC, 3A (AC-15)
 *5) Illuminated unit with four contact blocks with transformer and DC-DC converter types: 500 m/s²

Degree of Protection

Unit		IEC 60529
A□□□□ (Part number that starts with "A")	Pushbutton Pilot light Illuminated pushbutton with round lens Selector switch	IP65
	Pushlock key reset pushbutton Illuminated selector switch Key selector switch	IP54

For harsh environment such as torrid/frigid area

TW series for harsh environment such as torrid/frigid area is also available (not approved by standards). Contact IDEC for details.

APEM

Switches & Pilot Lights

Control Boxes

Emergency Stop Switches

Enabling Switches

Safety Products

Explosion Proof

Terminal Blocks

Relays & Sockets

Circuit Protectors

Power Supplies

LED Illumination

Controllers

Operator Interfaces

Sensors

AUTO-ID

Flush Silhouette

ø16

ø22

ø30

Miniature

Pilot Lights

HW

TW

YW



Mounting Hole Layout

Panel Cut (IEC60947-5-1)

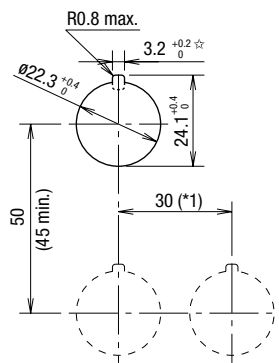

All dimensions in mm.

- The minimum mounting centers are applicable to switches with one layer of contact blocks (one to two contact blocks). When two layers of contact blocks are mounted, determine the minimum mounting centers in consideration of convenience for wiring.
 - 1*) ø40 mm mushroom button type: 40 mm minimum
 - 1*) 2-position, 3-position lever selector switch: 39 mm minimum
 - 1*) 4-position, 5-position lever selector switch: 50 mm minimum
- When high temperature is expected, take necessary measures such as securing sufficient mounting centers or using a cooling fan.
- The ☆3.2^{+0.2} mm recess is for preventing rotation and is not necessary when the nameplate or anti-rotation ring is not used.

Ordering Information

Standard models

- Specify Ordering No. when ordering.
- Specify a button or lens color code in place of *.
- An LED lamp is installed in pilot lights, illuminated pushbuttons, and illuminated selector switches unless otherwise specified.
- Pilot light of full voltage adapter type is equipped with a terminal cover.
- Nameplates and accessories are ordered separately. See **B-256** to **B-259**.

- Color codes for units without LED lamps:

R (red), G (green), A (amber), Y (yellow), S (blue)

When using a commercially available lamp, choose a lamp with rated voltage 5 to 30V AC/DC and 1W maximum, and with the same base and shape.

Make sure of correct operation before installation. The operation of TW series cannot be guaranteed when a commercially available lamp is used.

Pushbuttons (B-238 to B-240)

When specifying gold-plated silver contact and contact configuration:

ABW 1 11 R - MAU

Optional contact
Contact configuration

MAU: Gold contact

10: 1NO
 01: 1NC
 11: 1NO1NC
 20: 2NO
 02: 2NC
 22: 2NO2NC
 40: 4NO
 04: 4NC
 13: 1NO3NC
 31: 3NO1NC
 30: 3NO
 03: 3NC
 12: 1NO2NC
 21: 2NO1NC

- Pushbuttons with 1 or 3 contact blocks have a dummy block.
- Push-pull type AYW4 (B-240) can have a maximum of two contact blocks.

Pilot Lights (B-241)

When specifying LED operating voltage:

APW 2 126 DR

Operating voltage

99: Without LED lamp
 66: 6V AC/DC
 11: 12V AC/DC
 22: 24V AC/DC
 16: 100/110V AC
 126: 115/120V AC
 26: 200/220V AC
 246: 230/240V AC
 386: 380V AC
 46: 400/440V AC
 486: 480V AC

- See **B-237** for how to specify 110V DC type (DC-DC converter).

Note: Color codes for units without LED lamps: R (red), G (green), A (amber), Y (yellow), S (blue)

When using a commercially available lamp, choose a lamp with rated voltage 5 to 30V AC/DC and 1W maximum, and with the same base and shape. Make sure of correct operation before installation. The operation of TW series cannot be guaranteed when a commercially available lamp is used.

Ordering Information

Illuminated Pushbuttons (B-243 to B-246)

When specifying gold-plated silver contact, contact configuration, and LED operating voltage:

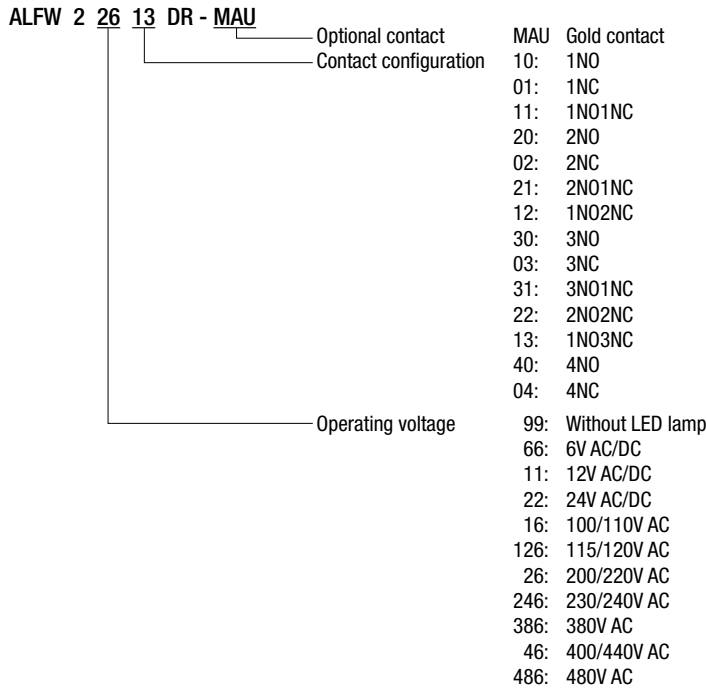

Note:

- Illuminated pushbuttons of 24V AC/DC and below with 2 or 4 contact blocks have a dummy block.
- Illuminated pushbuttons of 100V AC and over is not available with 1 or 3 contact blocks.
- See B-237 for how to specify 110V DC type (DC-DC converter).
- Color codes for units without LED lamps:
R (red), G (green), A (amber), Y (yellow), S (blue)
When using a commercially available lamp, choose a lamp with rated voltage 5 to 30V AC/DC and 1W maximum, and with the same base and shape. Make sure of correct operation before installation. The operation of TW series cannot be guaranteed when a commercially available lamp is used.

Selector Switches (B-249 to B-251)

When specifying gold-plated silver contact, key removal position, and key number:

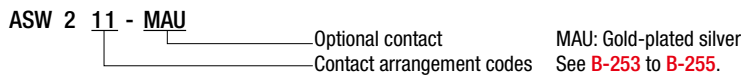

How to specify key removal/retained position

Position	Removable Position	Code	Part No. Example
2-position	Maintained	Removable in all positions	— ASW2K20
		Removable in left only	B ASW2K20B
		Removable in right only	C ASW2K20C
	Spring return from right	Removable in left only	— ASW21K20
	Spring return from left	Removable in right only	— ASW22K20
3-position	Maintained	Removable in all positions	— ASW3K20
		Removable in left and center only	B ASW3K20B
		Removable in right and center only	C ASW3K20C
		Removable in center only	D ASW3K20D
		Removable in right and left only	E ASW3K20E
		Removable in left only	G ASW3K20G
		Removable in right only	H ASW3K20H
		Spring return from right	Removable in left and center only
	Removable in center only		D ASW31K20D
	Removable in left only		G ASW31K20G
	Spring return from left	Removable in right and center only	— ASW32K20
		Removable in center only	D ASW32K20D
		Removable in right only	H ASW32K20H
	Spring return two-way	Removable in center only	— ASW33K20

- The key cannot be removed in a spring returned position.



Download catalogs and CAD from <http://eu.idec.com/downloads>

APEM

Switches & Pilot Lights

Control Boxes

Emergency Stop Switches

Enabling Switches

Safety Products

Explosion Proof

Terminal Blocks

Relays & Sockets

Circuit Protectors

Power Supplies

LED Illumination

Controllers

Operator Interfaces

Sensors

AUTO-ID

Flush Silhouette

ø16

ø22

ø30

Miniature

Pilot Lights

HW

TW

YW

Ordering Information

Illuminated selector switches (B-252)

When specifying gold-plated silver contact, contact configuration, and LED operating voltage:

ASLW 2 136 22 DR - MAU

Optional contact
Contact arrangement codes
Operating Voltage

MAU Gold contact
See B-253 to B-255.

99: Without LED lamp
66: 6V AC/DC
11: 12V AC/DC
22: 24V AC/DC
16: 100/110V AC
136: 115/120V AC
26: 200/220V AC
256: 230/240V AC
386: 380V AC
46: 400/440V AC
486: 480V AC

Note:

- Illuminated selector switches of 24V AC/DC and below with 2 or 4 contact blocks have a dummy block.
 - Illuminated selector switches of 100V AC and over is not available with 1 or 3 contact blocks.
 - See below for how to specify 110V DC type (DC-DC converter).
 - Color codes for units without LED lamps:
R (red), G (green), A (amber), Y (yellow), S (blue)
- When using a commercially available lamp, choose a lamp with rated voltage 5 to 30V AC/DC and 1W maximum, and with the same base and shape. Make sure of correct operation before installation. The operation of TW series cannot be guaranteed when a commercially available lamp is used.

DC-DC Converter (110V DC)

When specifying illuminated pushbuttons, illuminated selector switches, and pilot lights:

ALW 2 16 22 DDG

Operating Voltage 16□□D

ASLW 2 16 11 DDY

Operating Voltage 16□□D

APW 1 16 DDR







Operating Voltage 16□□D

Note:

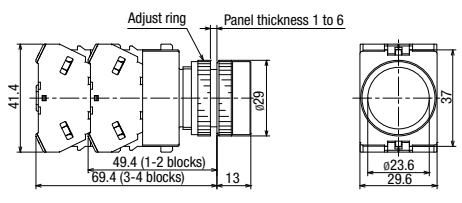
- DC-DC converter type (110V DC) is not approved by standards (90 to 140V DC).
- DC-DC converter type is not available with 1 or 3 contact blocks.

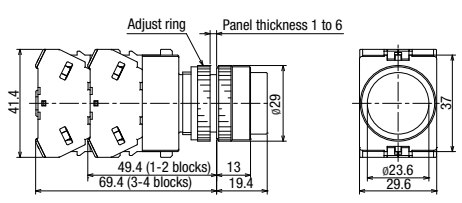
Flush / Extended / Mushroom Pushbuttons

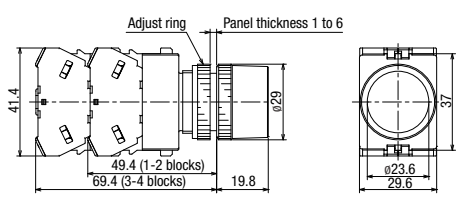
Package Quantity: 1

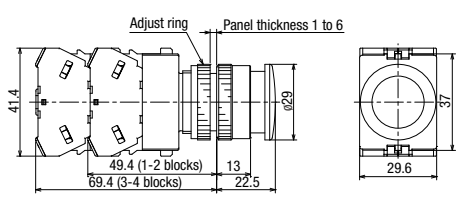
Shape	Operation	Contact	Part No.	Color Code	Dimensions (mm)
Flush ABW1 AOW1 	Momentary	1NO	ABW110*	B G R Y S W	
		1NC	ABW101*		
		1NO-1NC	ABW111*		
		2NO	ABW120*		
		2NC	ABW102*		
		2NO-2NC	ABW122*		
	Maintained	1NO	AOW110*		
		1NC	AOW101*		
		1NO-1NC	AOW111*		
		2NO	AOW120*		
		2NC	AOW102*		
		2NO-2NC	AOW122*		
Extended ABW2 AOW2 	Momentary	1NO	ABW210*	B G R Y S W	
		1NC	ABW201*		
		1NO-1NC	ABW211*		
		2NO	ABW220*		
		2NC	ABW202*		
		2NO-2NC	ABW222*		
	Maintained	1NO	AOW210*		
		1NC	AOW201*		
		1NO-1NC	AOW211*		
		2NO	AOW220*		
		2NC	AOW202*		
		2NO-2NC	AOW222*		
Extended with Full Shroud ABFW2 AOFW2 	Momentary	1NO	ABFW210*	B G R Y S W	
		1NC	ABFW201*		
		1NO-1NC	ABFW211*		
		2NO	ABFW220*		
		2NC	ABFW202*		
		2NO-2NC	ABFW222*		
	Maintained	1NO	AOFW210*		
		1NC	AOFW201*		
		1NO-1NC	AOFW211*		
		2NO	AOFW220*		
		2NC	AOFW202*		
		2NO-2NC	AOFW222*		
ø29mm Mushroom ABW3 AOW3 	Momentary	1NO	ABW310*	B G R Y S W	
		1NC	ABW301*		
		1NO-1NC	ABW311*		
		2NO	ABW320*		
		2NC	ABW302*		
		2NO-2NC	ABW322*		
	Maintained	1NO	AOW310*		
		1NC	AOW301*		
		1NO-1NC	AOW311*		
		2NO	AOW320*		
		2NC	AOW302*		
		2NO-2NC	AOW322*		

- APEM
- Switches & Pilot Lights
- Control Boxes
- Emergency Stop Switches
- Enabling Switches
- Safety Products
- Explosion Proof
- Terminal Blocks
- Relays & Sockets
- Circuit Protectors
- Power Supplies
- LED Illumination
- Controllers
- Operator Interfaces
- Sensors
- AUTO-ID
- Flush Silhouette
- ø16
- ø22
- ø30
- Miniature
- Pilot Lights
- HW
- TW
- YW

- Specify a color code in place of * in Part No.
B: black, G: green, R: red, Y: yellow, S: blue, W: white
- Round bezel: Mat aluminum color

- Pushbuttons with 1 or 3 contact blocks have a dummy block.
- See B-235 for other contact configurations and gold-plated silver contacts.
- Pushbuttons: M3.5 Terminal screws



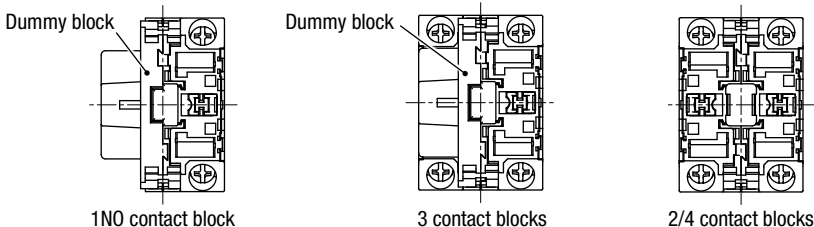





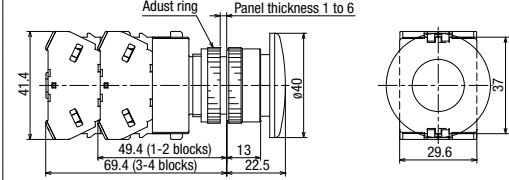

Bottom View (non-illuminated)

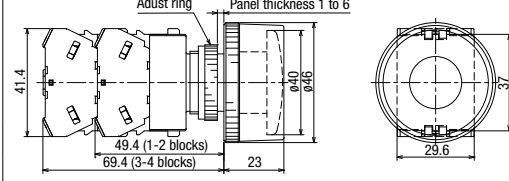

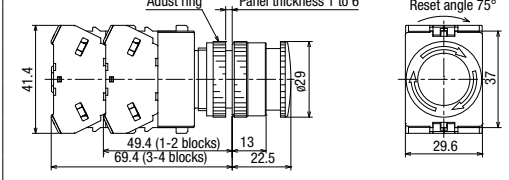
- For 1 NC contact, the contact block will mount on the opposite side.
- See B-267 for wiring.
- Integrated terminal cover

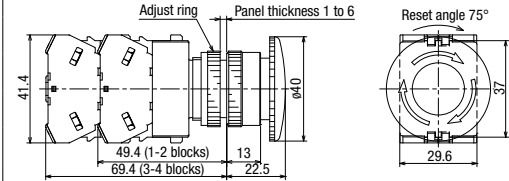
Mushroom / Pushlock Turn Reset / Push Turn Lock / Pushlock Key Reset

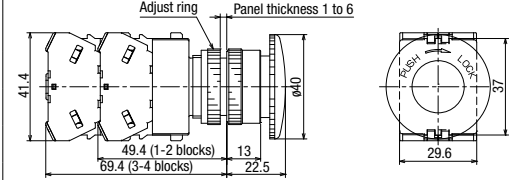
Package Quantity: 1

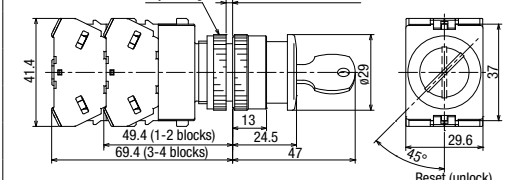
Shape	Operation	Contact	Part No.	Color Code	Dimensions (mm)
ø40mm Mushroom ABW4 AOW4 	Momentary	1NO	ABW410*	B G R Y S W	
		1NC	ABW401*		
		1NO-1NC	ABW411*		
		2NO	ABW420*		
		2NC	ABW402*		
	Maintained	1NO	AOW410*		
		1NC	AOW401*		
		1NO-1NC	AOW411*		
		2NO	AOW420*		
		2NC	AOW402*		
ø40mm Mushroom w/Full Shroud ABGW4 	Momentary	1NO	ABGW410*	B G R Y S W	
		1NC	ABGW401*		
		1NO-1NC	ABGW411*		
		2NO	ABGW420*		
		2NC	ABGW402*		
		2NO-2NC	ABGW422*		
ø29mm Mushroom Pushlock Turn Reset (*1) AVW3 	Momentary	1NO	AVW310*	R Y	
		1NC	AVW301*		
		1NO-1NC	AVW311*		
		2NO	AVW320*		
		2NC	AVW302*		
		2NO-2NC	AVW322*		
ø40mm Mushroom Pushlock Turn Reset (*1) AVW4 	Momentary	1NO	AVW410*	R Y	
		1NC	AVW401*		
		1NO-1NC	AVW411*		
		2NO	AVW420*		
		2NC	AVW402*		
		2NO-2NC	AVW422*		
ø40mm Mushroom Push Turn Lock AJW4 	Momentary	1NO	AJW410*	B G R Y	
		1NC	AJW401*		
		1NO-1NC	AJW411*		
		2NO	AJW420*		
		2NC	AJW402*		
		2NO-2NC	AJW422*		
ø29mm Mushroom Pushlock Key Reset (*1) AXW3 	Momentary	1NO	AXW310R	R	
		1NC	AXW301R		
		1NO-1NC	AXW311R		
		2NO	AXW320R		
		2NC	AXW302R		
		2NO-2NC	AXW322R		

- Specify a color code in place of * in Part No. B (black), G (green), R (red), Y (yellow), S (blue), W (white)
- Round bezel (metal): Mat aluminum color
- Pushbuttons with one or three contact blocks contain a dummy block.
- See **B-235** for other contact configurations and gold-plated silver contacts.
- Pushbuttons: terminal screws M3.5, integrated terminal cover
- See **B-238** for bottom view.







*1) AVW3, AVW4, and AXW3 pushbuttons cannot be used as emergency stop switches. When emergency stop switches are required, use XW series pushbuttons (ISO 13850 and IEC 60947-5-5 compliant).

Pushbutton operation**Push Turn Lock**

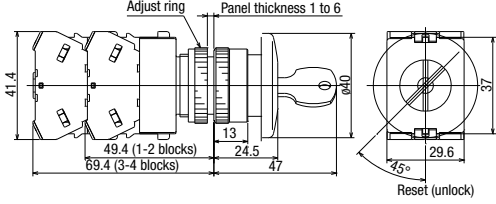
Button is locked when turned clockwise in the depressed position and is reset when turned counterclockwise.

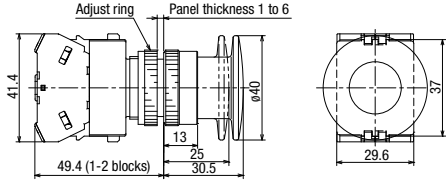
Pushlock Key Reset / Push-Pull / Square Flush / Square Extended

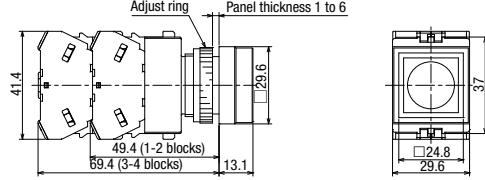
Package Quantity: 1

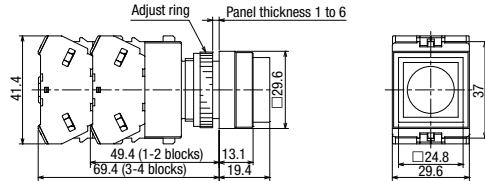
Shape	Operation	Contact	Part No.	Color Code	Dimensions (mm)
ø40mm Mushroom Pushlock Key Reset (*1) AXW4 		1NO	AXW410R	R	
		1NC	AXW401R		
		1NO-1NC	AXW411R		
		2NO	AXW420R		
		2NC	AXW402R		
		2NO-2NC	AXW422R		
ø40mm Mushroom Push-Pull AYW4 		1NO	AYW410*	B G R Y S W	
		1NC	AYW401*		
		1NO-1NC	AYW411*		
		2NO	AYW420*		
		2NC	AYW402*		
Square Flush ABQW1 AOQW1 	Momentary	1NO	ABQW110*	B G R Y S W	
		1NC	ABQW101*		
		1NO-1NC	ABQW111*		
		2NO	ABQW120*		
		2NC	ABQW102*		
		2NO-2NC	ABQW122*		
	Maintained	1NO	AOQW110*		
		1NC	AOQW101*		
		1NO-1NC	AOQW111*		
		2NO	AOQW120*		
		2NC	AOQW102*		
		2NO-2NC	AOQW122*		
Square Extended ABQW2 AOQW2 	Momentary	1NO	ABQW210*	B G R Y S W	
		1NC	ABQW201*		
		1NO-1NC	ABQW211*		
		2NO	ABQW220*		
		2NC	ABQW202*		
		2NO-2NC	ABQW222*		
	Maintained	1NO	AOQW210*		
		1NC	AOQW201*		
		1NO-1NC	AOQW211*		
		2NO	AOQW220*		

- Specify a color code in place of * in Part No. B (black), G (green), R (red), Y (yellow), S (blue), W (white)
- Round bezel (metal): Mat aluminum color
- Square bezel (plastic): Black
- Pushbuttons with one or three contact blocks contain a dummy block.
- See B-235 for other contact configurations and gold-plated silver contacts.
- Push-pull switch can have a maximum of two contact blocks.
- Pushbuttons: terminal screws M3.5, integrated terminal cover
- See B-238 for bottom view.











*1) AXW4 pushbuttons with red operator cannot be used as emergency stop switches. When emergency stop switches are required, use XW series pushbuttons (ISO 13850 and IEC 60947-5-5 compliant).

Pushbutton operation

Push-Pull

2-position switches with button maintained in both depressed and reset positions.

Push-Pull contact operation

Contact	AYW4	
	Push	Pull
1NO		
1NC		
1NO-1NC		
2NO		
2NC		

APEM

Switches & Pilot Lights

Control Boxes

Emergency Stop Switches

Enabling Switches

Safety Products

Explosion Proof

Terminal Blocks

Relays & Sockets

Circuit Protectors

Power Supplies

LED Illumination

Controllers

Operator Interfaces

Sensors

AUTO-ID

Flush Silhouette

ø16

ø22

ø30

Miniature

Pilot Lights

HW

TW

YW



Round Flush / Dome / Square Flush Pilot Lights

Package Quantity: 1

Shape	Illumination	Rated Voltage	Part No.	Color Code
Round Flush APW1 (24V AC/DC) (100/110V AC) (200/220V AC) With transformer (100/110V AC)	LED	24V AC/DC	APW122D*	R G Y A S PW
		100/110V AC	APW116D*	
		200/220V AC	APW126D*	
Round Flush (Marking) APW1B (24V AC/DC) (100/110V AC) (200/220V AC) With transformer (100/110V AC)	LED	24V AC/DC	APW1B22D*	R G Y A S PW
		100/110V AC	APW1B16D*	
		200/220V AC	APW1B26D*	
Dome APW2 (24V AC/DC) (100/110V AC) (200/220V AC) With transformer (100/110V AC)	LED	24V AC/DC	APW222D*	R G Y A S PW
		100/110V AC	APW216D*	
		200/220V AC	APW226D*	
Square Flush (Marking) APQW1B (24V AC/DC) (100/110V AC) (200/220V AC) With transformer (100/110V AC)	LED	24V AC/DC	APQW1B22D*	R G Y A S PW
		100/110V AC	APQW1B16D*	
		200/220V AC	APQW1B26D*	

- Specify a color code in place of * in Part No. R (red), G (green), Y (yellow), A (amber), S (blue), PW (pure white)
- An LED lamp is installed in pilot lights unless otherwise specified.
- The PW (pure white) lens of marking type consists of a clear lens and a white marking plate.
- See **B-265** for marking plate size and engraving area.
- Round bezel (metal): Mat aluminum color
- Square bezel (plastic): Black
- See **B-235** for other contact configurations.
- See **B-235** for other operating voltage such as 6V AC/DC, 12V AC/DC, and 110V DC.
- See **B-235** for how to specify units without LED lamps. When using a commercially available lamp, choose a lamp with rated voltage 5 to 30V AC/DC and 1W maximum, and with the same base and shape. The operation of pilot lights cannot be guaranteed when a commercially available lamp is used.

Dimensions

Package Quantity: 1

Round Flush

Terminal screws: M3.5

APW1/APW1B

6, 12, 24V AC/DC, Without LED lamp

100/110V AC, 200/220V AC (240V AC maximum)

110V DC, 380V AC minimum

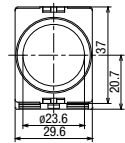
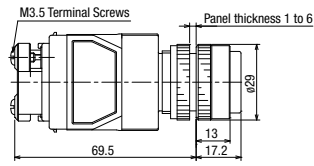
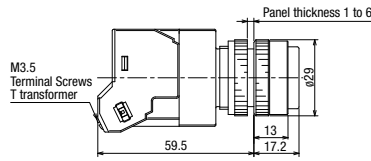
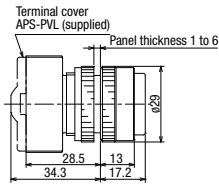

Dome

Terminal screws: M3.5

APW2

6, 12, 24V AC/DC, Without LED lamp

100/110V AC, 200/220V AC (240V AC maximum)

110V DC, 380V AC minimum

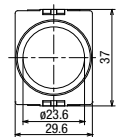
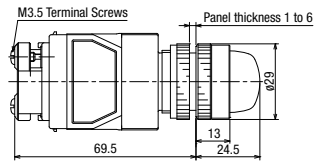
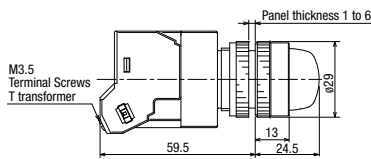
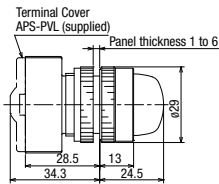

Square Flush (Marking Type)

Terminal screws: M3.5

APQW1B

6, 12, 24V AC/DC, Without LED lamp

100/110V AC, 200/220V AC (240V AC maximum)

110V DC, 380V AC minimum

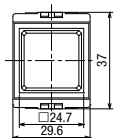
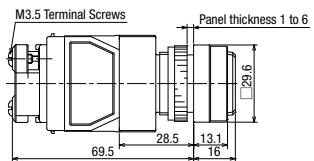
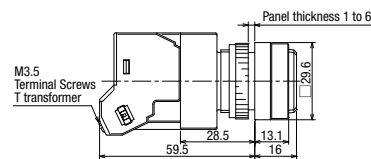
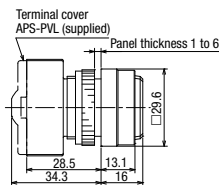

Bottom View

6, 12, 24V AC/DC, Without LED lamp

100/110V AC, 200/220V AC (240V AC maximum)

110V DC, 380V AC minimum

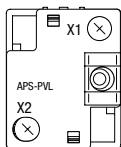

With terminal cover (APS-PVL)

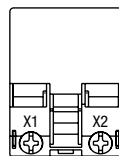

Integrated terminal cover

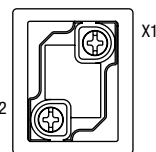

For DC-DC Converter types, terminal X1 is ⊕, X2 is ⊖. Integrated terminal cover

• See B-268 for wiring.

APEM

Switches & Pilot Lights

Control Boxes

Emergency Stop Switches

Enabling Switches

Safety Products

Explosion Proof

Terminal Blocks

Relays & Sockets

Circuit Protectors

Power Supplies

LED Illumination

Controllers

Operator Interfaces

Sensors

AUTO-ID

Flush Silhouette

ø16

ø22

ø30

Miniature

Pilot Lights

HW

TW

YW



ø22 TW Series Illuminated Pushbuttons

LED

Round Extended / Round Extended (Marking Type)

Package Quantity: 1

Shape	Illumination	Operation	Rated Voltage	Contact Configuration	Part No.	Color Code		
Round Extended ALW2 AOLW2 (24V AC/DC) With transformer (100/110V AC)	LED	Momentary	24V AC/DC	1NO-1NC	ALW22211D*	R G Y A S PW		
				2NO	ALW22220D*			
				2NO-2NC	ALW22222D*			
			100/110V AC	1NO-1NC	ALW21611D*			
				2NO	ALW21620D*			
				2NO-2NC	ALW21622D*			
		200/220V AC	1NO-1NC	ALW22611D*				
			2NO	ALW22620D*				
			2NO-2NC	ALW22622D*				
		Round Extended (Marking) ALW2B AOLW2B (24V AC/DC) With transformer (100/110V AC)	LED	Momentary	24V AC/DC	1NO-1NC	ALW2B2211D*	R G Y A S PW
						2NO	ALW2B2220D*	
						2NO-2NC	ALW2B2222D*	
100/110V AC	1NO-1NC				ALW2B1611D*			
	2NO				ALW2B1620D*			
	2NO-2NC				ALW2B1622D*			
200/220V AC	1NO-1NC			ALW2B2611D*				
	2NO			ALW2B2620D*				
	2NO-2NC			ALW2B2622D*				
Round Extended (Marking) ALW2B AOLW2B (24V AC/DC) With transformer (100/110V AC)	LED			Maintained	24V AC/DC	1NO-1NC	AOLW2B2211D*	R G Y A S PW
						2NO	AOLW2B2220D*	
						2NO-2NC	AOLW2B2222D*	
		100/110V AC	1NO-1NC		AOLW2B1611D*			
			2NO		AOLW2B1620D*			
			2NO-2NC		AOLW2B1622D*			
200/220V AC	1NO-1NC	AOLW2B2611D*						
	2NO	AOLW2B2620D*						
	2NO-2NC	AOLW2B2622D*						

- Specify a color code in place of * in Part No. R (red), G (green), Y (yellow), A (amber), S (blue), PW (pure white)
- The PW (pure white) lens of marking type consists of a clear lens and a white marking plate.
- See **B-265** for marking plate size and engraving area.
- An LED lamp is installed in illuminated pushbuttons unless otherwise specified.
- Round bezel (metal): Mat aluminum color
- See **B-236** for other operating voltage such as 6V AC/DC, 12V AC/DC, and 110V DC.
- See **B-236** for other contact configurations and gold-plated silver contacts.
- Illuminated pushbuttons of 24V AC/DC or below with 2 or 4 contact blocks have a dummy block.
- See **B-236** for how to specify units without LED lamps. When using a commercially available lamp, choose a lamp with rated voltage 5 to 30V AC/DC and 1W maximum, and with the same base and shape. The operation of pilot lights cannot be guaranteed when a commercially available lamp is used.

LED | **Round Extended with Full Shroud / Round Extended with Full Shroud (Marking Type)**

Package Quantity: 1

Shape	Illumination	Operation	Rated Voltage	Contact Configuration	Part No.	Color Code
Round Extended with Full Shroud ALFW2 AOLFW2 (24V AC/DC) With transformer (100/110V AC)	LED	Momentary	24V AC/DC	1NO-1NC	ALFW22211D*	R G Y A S PW
				2NO	ALFW22220D*	
				2NO-2NC	ALFW22222D*	
			100/110V AC	1NO-1NC	ALFW21611D*	
				2NO	ALFW21620D*	
				2NO-2NC	ALFW21622D*	
			200/220V AC	1NO-1NC	ALFW22611D*	
				2NO	ALFW22620D*	
				2NO-2NC	ALFW22622D*	
		Maintained	24V AC/DC	1NO-1NC	AOLFW22211D*	R G Y A S PW
				2NO	AOLFW22220D*	
				2NO-2NC	AOLFW22222D*	
			100/110V AC	1NO-1NC	AOLFW21611D*	
				2NO	AOLFW21620D*	
				2NO-2NC	AOLFW21622D*	
			200/220V AC	1NO-1NC	AOLFW22611D*	
				2NO	AOLFW22620D*	
				2NO-2NC	AOLFW22622D*	
Round Extended with Full Shroud (Marking Type) ALFW2B AOLFW2B (24V AC/DC) With transformer (100/110V AC)	LED	Momentary	24V AC/DC	1NO-1NC	ALFW2B2211D*	R G Y A S PW
				2NO	ALFW2B2220D*	
				2NO-2NC	ALFW2B2222D*	
			100/110V AC	1NO-1NC	ALFW2B1611D*	
				2NO	ALFW2B1620D*	
				2NO-2NC	ALFW2B1622D*	
			200/220V AC	1NO-1NC	ALFW2B2611D*	
				2NO	ALFW2B2620D*	
				2NO-2NC	ALFW2B2622D*	
		Maintained	24V AC/DC	1NO-1NC	AOLFW2B2211D*	R G Y A S PW
				2NO	AOLFW2B2220D*	
				2NO-2NC	AOLFW2B2222D*	
			100/110V AC	1NO-1NC	AOLFW2B1611D*	
				2NO	AOLFW2B1620D*	
				2NO-2NC	AOLFW2B1622D*	
			200/220V AC	1NO-1NC	AOLFW2B2611D*	
				2NO	AOLFW2B2620D*	
				2NO-2NC	AOLFW2B2622D*	

- Specify a color code in place of * in Part No. R (red), G (green), Y (yellow), A (amber), S (blue), PW (pure white)
- The PW (pure white) lens of marking type consists of a clear lens and a white marking plate.
- See **B-265** for marking plate size and engraving area.
- An LED lamp is installed in illuminated pushbuttons unless otherwise specified.
- Round bezel (metal): Mat aluminum color
- See **B-236** for other operating voltage such as 6V AC/DC, 12V AC/DC, and 110V DC.
- See **B-236** for other contact configurations and gold-plated silver contacts.
- Illuminated pushbuttons of 24V AC/DC or below with 2 or 4 contact blocks have a dummy block.
- See **B-236** for how to specify units without LED lamps. When using a commercially available lamp, choose a lamp with rated voltage 5 to 30V AC/DC and 1W maximum, and with the same base and shape. The operation of pilot lights cannot be guaranteed when a commercially available lamp is used.

APEM

Switches & Pilot Lights

Control Boxes

Emergency Stop Switches

Enabling Switches

Safety Products

Explosion Proof

Terminal Blocks

Relays & Sockets

Circuit Protectors

Power Supplies

LED Illumination

Controllers

Operator Interfaces

Sensors

AUTO-ID

Flush Silhouette

ø16

ø22

ø30

Miniature

Pilot Lights

HW

TW



YW

ø22 TW Series Illuminated Pushbuttons

LED

Square Extended (Marking Type)

Package Quantity: 1

Shape	Illumination	Operation	Rated Voltage	Contact Configuration	Part No.	Color Code			
Square Extended (Marking Type) ALQW2B AOLQW2B  (24V AC/DC)	LED	Momentary	24V AC/DC	1NO-1NC	ALQW2B2211D*	R G Y A S PW			
				2NO	ALQW2B2220D*				
				2NO-2NC	ALQW2B2222D*				
			100/110V AC	1NO-1NC	ALQW2B1611D*				
				2NO	ALQW2B1620D*				
				2NO-2NC	ALQW2B1622D*				
		200/220V AC	1NO-1NC	ALQW2B2611D*					
			2NO	ALQW2B2620D*					
			2NO-2NC	ALQW2B2622D*					
		 With transformer (100/110V AC)	LED	Maintained	24V AC/DC		1NO-1NC	AOLQW2B2211D*	R G Y A S PW
							2NO	AOLQW2B2220D*	
							2NO-2NC	AOLQW2B2222D*	
100/110V AC	1NO-1NC				AOLQW2B1611D*				
	2NO				AOLQW2B1620D*				
	2NO-2NC				AOLQW2B1622D*				
200/220V AC	1NO-1NC			AOLQW2B2611D*					
	2NO			AOLQW2B2620D*					
	2NO-2NC			AOLQW2B2622D*					

- Specify a color code in place of * in Part No. R (red), G (green), Y (yellow), A (amber), S (blue), PW (pure white)
- The PW (pure white) lens of marking type consists of a clear lens and a white marking plate.
- See **B-265** for marking plate size and engraving area.
- An LED lamp is installed in illuminated pushbuttons unless otherwise specified.
- Square bezel (plastic): Black
- See **B-236** for other operating voltage such as 6V AC/DC, 12V AC/DC, and 110V DC.
- See **B-236** for other contact configurations and gold-plated silver contacts.
- Illuminated pushbuttons of 24V AC/DC or below with 2 or 4 contact blocks have a dummy block.
- See **B-236** for how to specify units without LED lamps. When using a commercially available lamp, choose a lamp with rated voltage 5 to 30V AC/DC and 1W maximum, and with the same base and shape. The operation of pilot lights cannot be guaranteed when a commercially available lamp is used.

ø16

ø22

ø30

Miniature

Pilot Lights

HW

TW

YW

APEM

Switches & Pilot Lights

Control Boxes

Emergency Stop Switches

Enabling Switches

Safety Products

Explosion Proof

Terminal Blocks

Relays & Sockets

Circuit Protectors

Power Supplies

LED Illumination

Controllers

Operator Interfaces

Sensors

AUTO-ID

Flush Silhouette

ø16

ø22

ø30

Miniature

Pilot Lights

HW

TW

YW

LED

Mushroom ø29 / ø40 Pushlock Turn Reset

Package Quantity: 1

Shape	Illumination	Rated Voltage	Contact Configuration	Part No.	Color Code
ø29mm Mushroom Pushlock Turn Reset AVLW3 (*1) (24V AC/DC) With transformer (100/110V AC)	LED	24V AC/DC	1NO-1NC	AVLW32211D*	R
			2NO	AVLW32220D*	
			2NO-2NC	AVLW32222D*	
		100/110V AC	1NO-1NC	AVLW31611D*	
			2NO	AVLW31620D*	
			2NO-2NC	AVLW31622D*	
		200/220V AC	1NO-1NC	AVLW32611D*	
			2NO	AVLW32620D*	
			2NO-2NC	AVLW32622D*	
ø29mm Mushroom Pushlock Turn Reset (Marking type) AVLW3B (*1) (24V AC/DC) With transformer (100/110V AC)	LED	24V AC/DC	1NO-1NC	AVLW3B2211D*	R
			2NO	AVLW3B2220D*	
			2NO-2NC	AVLW3B2222D*	
		100/110V AC	1NO-1NC	AVLW3B1611D*	
			2NO	AVLW3B1620D*	
			2NO-2NC	AVLW3B1622D*	
		200/220V AC	1NO-1NC	AVLW3B2611D*	
			2NO	AVLW3B2620D*	
			2NO-2NC	AVLW3B2622D*	
ø40mm Mushroom Pushlock Turn Reset AVLW4 (*1) (24V AC/DC) With transformer (100/110V AC)	LED	24V AC/DC	1NO-1NC	AVLW42211D*	R
			2NO	AVLW42220D*	
			2NO-2NC	AVLW42222D*	
		100/110V AC	1NO-1NC	AVLW41611D*	
			2NO	AVLW41620D*	
			2NO-2NC	AVLW41622D*	
		200/220V AC	1NO-1NC	AVLW42611D*	
			2NO	AVLW42620D*	
			2NO-2NC	AVLW42622D*	
ø40mm Mushroom Pushlock Turn Reset (Marking type) AVLW4B (*1) (24V AC/DC) With transformer (100/110V AC)	LED	24V AC/DC	1NO-1NC	AVLW4B2211D*	R
			2NO	AVLW4B2220D*	
			2NO-2NC	AVLW4B2222D*	
		100/110V AC	1NO-1NC	AVLW4B1611D*	
			2NO	AVLW4B1620D*	
			2NO-2NC	AVLW4B1622D*	
		200/220V AC	1NO-1NC	AVLW4B2611D*	
			2NO	AVLW4B2620D*	
			2NO-2NC	AVLW4B2622D*	

- Specify a color code in place of * in Part No. R (red)
- See **B-265** for marking plate size and engraving area.
- An LED lamp is installed in illuminated pushbuttons unless otherwise specified.
- Round bezel (metal): Mat aluminum color
- See **B-236** for other operating voltage such as 6V AC/DC, 12V AC/DC, and 110V DC.
- See **B-236** for other contact configurations and gold-plated silver contacts.
- Illuminated pushbuttons of 24V AC/DC or below with 2 or 4 contact blocks have a dummy block.]
- See **B-236** for how to specify units without LED lamps. When using a commercially available lamp, choose a lamp with rated voltage 5 to 30V AC/DC and 1W maximum, and with the same base and shape. The operation of pilot lights cannot be guaranteed when a commercially available lamp is used.

*1) AVLW illuminated pushbuttons cannot be used as emergency stop switches. When emergency stop switches are required, use XW or HW series pushbuttons (ISO 13850 and IEC 60947-5-5 compliant).

ø22 TW Series Illuminated Pushbuttons

Dimensions

All dimensions in mm.

Round Extended

6, 12, 24V AC/DC, Without LED lamp

Terminal Screw: M3.5, integrated terminal cover

100/110V AC, 200/220V (240V AC maximum)

110V DC, 380V AC minimum

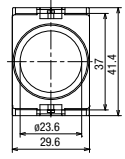
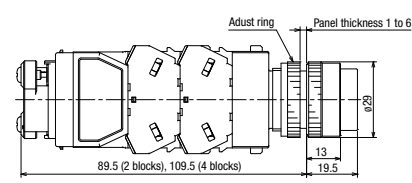
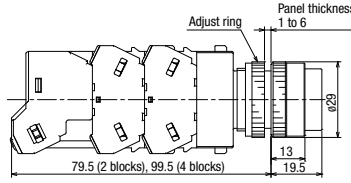
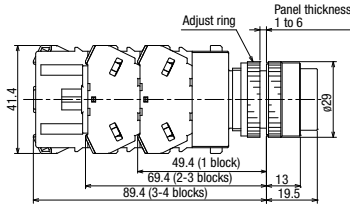

Round Extended with Full Shroud

6, 12, 24V AC/DC, Without LED lamp

Terminal Screw: M3.5, integrated terminal cover

100/110V AC, 200/220V (240V AC maximum)

110V DC, 380V AC minimum

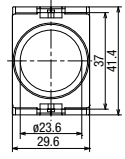
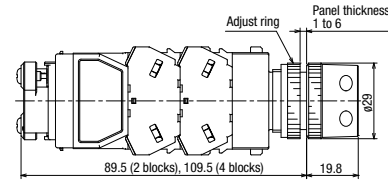
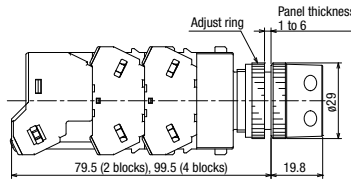
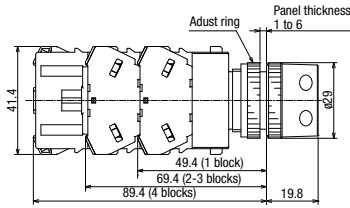

Square Extended

6, 12, 24V AC/DC, Without LED lamp

Terminal Screw: M3.5, integrated terminal cover

100/110V AC, 200/220V (240V AC maximum)

110V DC, 380V AC minimum

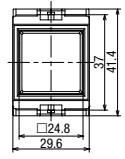
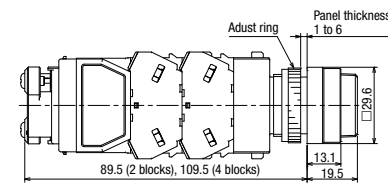
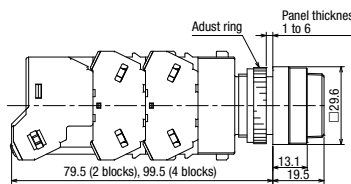
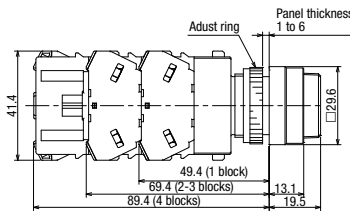

ø16

ø29mm Pushlock Turn Reset

6, 12, 24V AC/DC, Without LED lamp

Terminal Screw: M3.5, integrated terminal cover

100/110V AC, 200/220V (240V AC maximum)

110V DC, 380V AC minimum

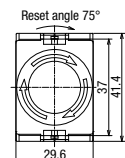
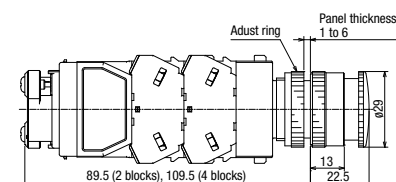
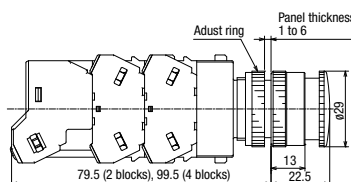
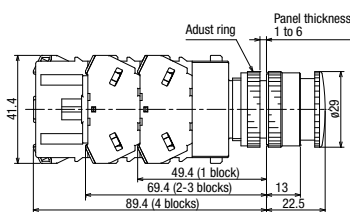

HW

TW

ø40mm Pushlock Turn Reset

6, 12, 24V AC/DC, Without LED lamp

Terminal Screw: M3.5, integrated terminal cover

100/110V AC, 200/220V (240V AC maximum)

110V DC, 380V AC minimum

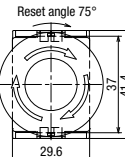
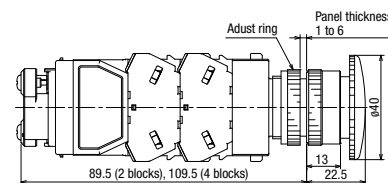
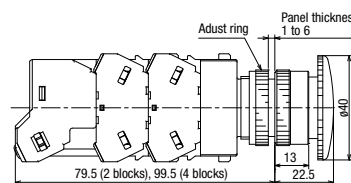
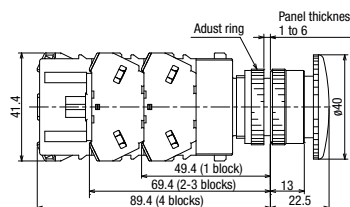

Bottom View (illuminated)

6, 12, 24V AC/DC, Without LED lamp

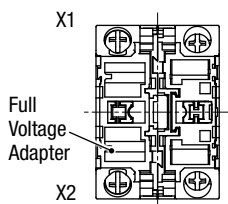

1 contact block

100/110V AC, 200/220V
(240V AC maximum)

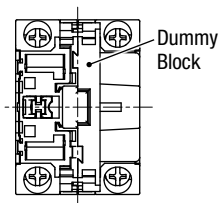
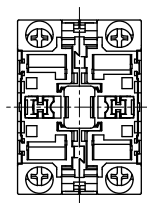
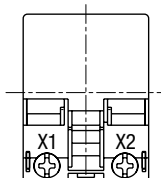

2/4 contact blocks

3 contact blocks

110V DC, 380V AC minimum

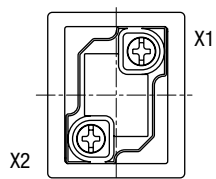

For DC-DC Converter types,
terminal X1 is ⊕, X2 is ⊖.

• See B-267 for wiring.

APEM

Switches & Pilot Lights

Control Boxes

Emergency Stop Switches

Enabling Switches

Safety Products

Explosion Proof

Terminal Blocks

Relays & Sockets

Circuit Protectors

Power Supplies

LED Illumination

Controllers

Operator Interfaces

Sensors

AUTO-ID

Flush Silhouette

ø16

ø22

ø30

Miniature

Pilot Lights

HW

TW

YW



Selector Switches (Knob Operator)

Package Quantity: 1

Shape	Knob Operator ASW													
	Contact Configuration						Maintained	Spring Return from Right	Spring Return from Left					
	Contact Code	Contact Block		Operator Position			$\begin{matrix} 1 \\ \vee \\ 2 \end{matrix}$	$\begin{matrix} 1 \\ \vee \\ 2 \end{matrix}$	Contact Block		Operator Position		$\begin{matrix} 1 \\ \vee \\ 2 \end{matrix}$	
Mounting Position		Contact	1	2		Mounting Position			Contact	1	2			
90° 2-position	1NO (10)	①	NO		●		ASW210	ASW2110	①	NO	●		ASW2210	
		②	—	Dummy Block					②	—	—			
	1NO-1NC (11)	①	NO		●		ASW211	ASW2111	①	NO	●		ASW2211	
		②	NC	●					②	NC		●		
	2NO (20)	①	NO		●		ASW220	ASW2120	①	NO	●		ASW2220	
		②	NO		●				②	NO	●			
	2NO-2NC (22)	①	NO		●		ASW222	ASW2122	①	NO	●		ASW2222	
		②	NC	●					②	NC		●		
③		NO		●	●	③			NO	●		●		
④		NC	●			④			NC		●	●		
45° 3-position	2NO (20)	①	NO	●			ASW320	ASW3120	$\begin{matrix} 1 \\ \vee \\ 0 \\ \vee \\ 2 \end{matrix}$				ASW3220	ASW3320
		②	NO			●								
	2NC (02)	①	NC			■	ASW302	ASW3102	$\begin{matrix} 1 \\ \vee \\ 0 \\ \vee \\ 2 \end{matrix}$				ASW3202	ASW3302
		②	NC	■										
	2NO-2NC (22)	①	NO	●			ASW322	ASW3122	$\begin{matrix} 1 \\ \vee \\ 0 \\ \vee \\ 2 \end{matrix}$				ASW3222	ASW3322
		②	NO			●								
		③	NC			■								
		④	NC	■										
	4NO (40)	①	NO	●			ASW340	ASW3140	$\begin{matrix} 1 \\ \vee \\ 0 \\ \vee \\ 2 \end{matrix}$				ASW3240	ASW3340
		②	NO			●								
		③	NO	●										
		④	NO			●								
	4NC (04)	①	NC			■	ASW304	ASW3104	$\begin{matrix} 1 \\ \vee \\ 0 \\ \vee \\ 2 \end{matrix}$				ASW3204	ASW3304
		②	NC	■										
		③	NC			■								
		④	NC	■										
	3S☆	①	NO	●			ASW33S-243☆	—	$\begin{matrix} 1 \\ \vee \\ 0 \\ \vee \\ 2 \end{matrix}$				—	—
		②	NO			●								
③		NC		●										
④		—	Dummy Block											

- HW • Knob operator: white indicator on black body
 • Cylinder: Mat aluminum color
- TW • Selector switches with one or three contact blocks contain a dummy block.
 • Spring return is not available with contact code 3S.
- YW • On the contact arrangement marked with ☆ in the table above, the rated current (load switching current) is reduced to a half of the related current of the contact block. The rated insulation voltage and the rated thermal current remain unchanged.
 • For models with ☆, contacts may overlap when the operator position is changed.
 • Other contact arrangements are also available. See **B-253** to **B-255**.
 • Optional selector operators and color inserts are available.
 • See **B-236** for gold-plated silver contacts.
 • Turn the operator to each position accurately.

Contact Block Mounting Position

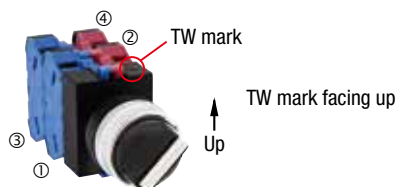

Dimensions

All dimensions in mm.

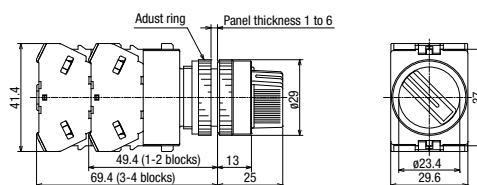
Terminal screw: M3.5
Integrated terminal cover• See **B-238** for bottom view.

Selector Switches (Lever Operator)

Package Quantity: 1

Shape	Lever Operator ASW□L														
	Contact Code	Contact Configuration		Maintained	Spring Return from Right	Spring Return from Left									
		Mounting Position	Contact			Operator Position							Mounting Position	Contact	Operator Position
90° 2-position	1NO (10)	①	NO		●	ASW2L10	ASW21L10	①	NO	●		ASW22L10			
		②	—	Dummy Block				②	—	—					
	1NO-1NC (11)	①	NO	●	●	ASW2L11	ASW21L11	①	NO	●		ASW22L11			
		②	NC					②	NC		●				
	2NO (20)	①	NO		●	ASW2L20	ASW21L20	①	NO	●		ASW22L20			
		②	NO		●			②	NO	●					
	2NO-2NC (22)	①	NO		●	ASW2L22	ASW21L22	①	NO	●		ASW22L22			
		②	NC	●				②	NC		●				
		③	NO		●			③	NO	●					
		④	NC	●				④	NC		●				
	45° 3-position	2NO (20)	①	NO	●		ASW3L20	ASW31L20	ASW32L20		ASW33L20				
			②	NO		●			ASW32L20		ASW33L20				
2NC (02)		①	NC		●	ASW3L02	ASW31L02	ASW32L02		ASW33L02					
		②	NC		●			ASW32L02		ASW33L02					
2NO-2NC (22)		①	NO	●		ASW3L22	ASW31L22	ASW32L22		ASW33L22					
		②	NO		●			ASW32L22		ASW33L22					
		③	NC		●			ASW32L22		ASW33L22					
		④	NC		●			ASW32L22		ASW33L22					
4NO (40)		①	NO	●		ASW3L40	ASW31L40	ASW32L40		ASW33L40					
		②	NO		●			ASW32L40		ASW33L40					
		③	NO		●			ASW32L40		ASW33L40					
		④	NO		●			ASW32L40		ASW33L40					
4NC (04)		①	NC		●	ASW3L04	ASW31L04	ASW32L04		ASW33L04					
		②	NC		●			ASW32L04		ASW33L04					
		③	NC		●			ASW32L04		ASW33L04					
		④	NC		●			ASW32L04		ASW33L04					
3S ☆		①	NO	●		ASW3L3S-243 ☆	—	—		—					
		②	NO		●			—		—					
		③	NC		●			—		—					
		④	—	Dummy Block				—		—					

- Lever operator: white indicator on black body
- Cylinder: Mat aluminum color
- Selector switches with one or three contact blocks contain a dummy block.
- Spring return is not available with contact code 3S.
- On the contact arrangement marked with ☆ in the table above, the rated current (load switching current) is reduced to a half of the related current of the contact block. The rated insulation voltage and the rated thermal current remain unchanged.
- For models with ☆, contacts may overlap when the operator position is changed.
- Other contact arrangements are also available. See B-253 to B-255.
- Optional selector operators and color inserts are available.
- See B-236 for gold-plated silver contacts.
- Turn the operator to each position accurately.

Contact Block Mounting Position

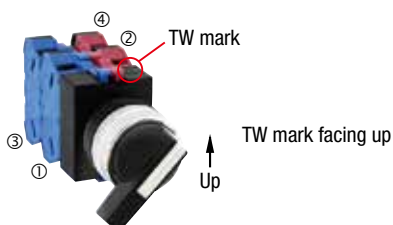

Dimensions

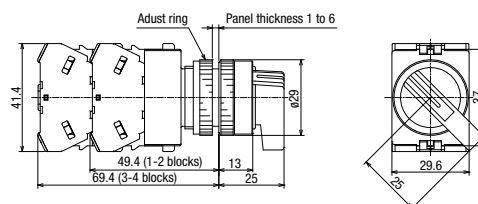

All dimensions in mm.

Terminal screw: M3.5
Integrated terminal cover

• See B-238 for bottom view.

Key Selector Switches

Package Quantity: 1

Shape	Key Selector Switch ASW□K (Key No. 0)														
	Contact Code	Contact Configuration		Maintained	Spring Return from Right	Spring Return from Left									
		Mounting Position	Contact			Operator Position							Mounting Position	Contact	Operator Position
90° 2-position	1NO (10)	①	NO		●	ASW2K10	ASW21K10	①	NO	●		ASW22K10			
		②	—	Dummy Block				②	—	—					
	1NO-1NC (11)	①	NO		●	ASW2K11	ASW21K11	①	NO	●		ASW22K11			
		②	NC	●				②	NC		●				
	2NO (20)	①	NO		●	ASW2K20	ASW21K20	①	NO	●		ASW22K20			
		②	NO		●			②	NO	●					
	2NO-2NC (22)	①	NO		●	ASW2K22	ASW21K22	NO	●		ASW22K22				
			NC	●				NC		●					
		②	NO		●			NO	●			●			
			NC	●				NC		●					
	45° 3-position	2NO (20)	①	NO	●		ASW3K20	ASW31K20	ASW32K20				ASW33K20		
			②	NO					●						
2NC (02)		①	NC			■	ASW3K02	ASW31K02	ASW32K02				ASW33K02		
		②	NC			■									
2NO-2NC (22)		①	NO	●			ASW3K22	ASW31K22	ASW32K22				ASW33K22		
			NC			■									
		②	NO			●									
			NC			■									
4NO (40)		①	NO	●			ASW3K40	ASW31K40	ASW32K40				ASW33K40		
		②	NO			●									
		③	NO	●											
		④	NO			●									
4NC (04)		①	NC			■	ASW3K04	ASW31K04	ASW32K04				ASW33K04		
		②	NC			■									
		③	NC			■									
		④	NC			■									
3S ☆		①	NO	●			ASW3K3S-243	—	—				—		
		②	NO			●									
		③	NC			●									
		④	—	Dummy Block											

- Cylinder cover: black
- Cylinder: Mat aluminum color
- On the spring-returned types, the key can be released only from the maintained position. On the maintained types, the key can be released from every position. Other key retained positions are also available. See **B-236**.
- Selector switches with one or three contact blocks contain a dummy block.
- On the contact arrangement marked with ☆ in the table above, the rated current (load switching current) is reduced to a half of the related current of the contact block. The rated insulation voltage and the rated thermal current remain unchanged.

- For models with ☆, contacts may overlap when the operator position is changed.
- Other contact arrangements are also available. See **B-253** to **B-255**.
- See **B-236** for gold-plated silver contacts.
- Key selector switch is supplied with two standard keys.
 - (1) Insert the key completely before turning the key, otherwise failure may result.
 - (2) Turn the operator to each position accurately.
- Different key number is available upon request. Contact IDEC.

Contact Block Mounting Position

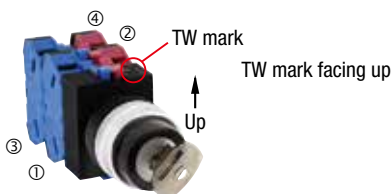

Dimensions

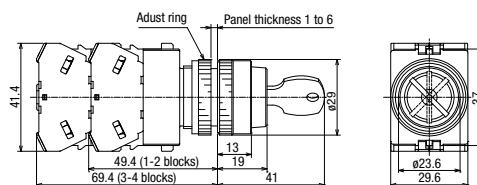

All dimensions in mm.

Terminal screw: M3.5
Integrated terminal cover• See **B-238** for bottom view.For more information, visit <http://eu.idec.com>

LED

Illuminated Selector Switches

Package Quantity: 1

Shape	ASLW										Color Code		
	Contact Code	Contact Block		Operator Position		Rated Voltage	Maintained 1 2	Spring Return from Right 1 2	Spring Return from Left				
		Mounting Position	Contact	1	2				Mounting Position	Contact		1	2
90° 2-position	1NO-1NC (11)	①	NO		●	24V AC/DC	ASLW22211D*	ASLW212211D*	①	NO	●	ASLW22211D*	
		②	NC	●		100/110V AC	ASLW21611D*	ASLW211611D*	②	NC		●	ASLW221611D*
						200/220V AC	ASLW22611D*	ASLW212611D*					ASLW222611D*
	2NO (20)	①	NO		●	24V AC/DC	ASLW22220D*	ASLW212220D*	①	NO	●		ASLW22220D*
		②	NO		●	100/110V AC	ASLW21620D*	ASLW211620D*	②	NO	●		ASLW221620D*
						200/220V AC	ASLW22620D*	ASLW212620D*					ASLW222620D*
	2NO-2NC (22)	①	NO		●	24V AC/DC	ASLW22222D*	ASLW212222D*	①	NO	●		ASLW22222D*
		②	NC	●		100/110V AC	ASLW21622D*	ASLW211622D*	②	NC		●	ASLW221622D*
		③	NO		●	200/220V AC	ASLW22622D*	ASLW212622D*	③	NO	●		ASLW222622D*
		④	NC	●					④	NC		●	

Shape	Contact Code	Contact Block		Operator Position			Rated Voltage	Maintained 1 0 2	Spring Return from Right 1 0 2	Spring return from left			Spring Return Two-way 1 0 2	Color Code		
		Mounting Position	Contact	1	0	2				Mounting Position	Contact	1			0	2
		45° 3-position	2NO (20)	①	NO	●						24V AC/DC			ASLW32220D*	ASLW312220D*
②	NO					●	100/110V AC	ASLW31620D*	ASLW311620D*			ASLW321620D*	ASLW331620D*			
							200/220V AC	ASLW32620D*	ASLW312620D*			ASLW322620D*	ASLW332620D*			
2NC (02)	①		NC			●	24V AC/DC	ASLW32202D*	ASLW312202D*			ASLW32202D*	ASLW332202D*			
	②		NC			●	100/110V AC	ASLW31602D*	ASLW311602D*			ASLW321602D*	ASLW331602D*			
							200/220V AC	ASLW32602D*	ASLW312602D*			ASLW322602D*	ASLW332602D*			
2NO-2NC (22)	①		NO	●			24V AC/DC	ASLW32222D*	ASLW312222D*			ASLW32222D*	ASLW332222D*			
	②		NO			●	100/110V AC	ASLW31622D*	ASLW311622D*			ASLW321622D*	ASLW331622D*			
	③		NC			●	200/220V AC	ASLW32622D*	ASLW312622D*			ASLW322622D*	ASLW332622D*			
	④		NC			●										
4NO (40)	①		NO	●			24V AC/DC	ASLW32240D*	ASLW312240D*			ASLW32240D*	ASLW332240D*			
	②		NO			●	100/110V AC	ASLW31640D*	ASLW311640D*			ASLW321640D*	ASLW331640D*			
	③		NO	●			200/220V AC	ASLW32640D*	ASLW312640D*			ASLW322640D*	ASLW332640D*			
	④		NO			●										
4NC (04)	①		NC			●	24V AC/DC	ASLW32204D*	ASLW312204D*			ASLW32204D*	ASLW332204D*			
	②		NC			●	100/110V AC	ASLW31604D*	ASLW311604D*			ASLW321604D*	ASLW331604D*			
	③		NC			●	200/220V AC	ASLW32604D*	ASLW312604D*			ASLW322604D*	ASLW332604D*			
	④		NC			●										

- Specify a color code in place of * in Part No. R (red), G (green), Y (yellow), A (amber), S (blue), PW (pure white)
- An LED lamp is installed in illuminated selector switches unless otherwise specified.
- Round bezel (metal): Mat aluminum color
- See B-237 for other operating voltage such as 6V AC/DC, 12V AC/DC, and 110V DC.
- Illuminated selector switches of 24V AC/DC or below with 2 or 4 contact blocks have a dummy block.

- Turn the operator to each position accurately.
- See B-253 to B-255 for other contact arrangements.
- See B-237 for gold-plated silver contacts.
- See B-237 for how to specify units without LED lamps. When using a commercially available lamp, choose a lamp with rated voltage 5 to 30V AC/DC and 1W maximum, and with the same base and shape. The operation of pilot lights cannot be guaranteed when a commercially available lamp is used.

Contact Block Mounting Position

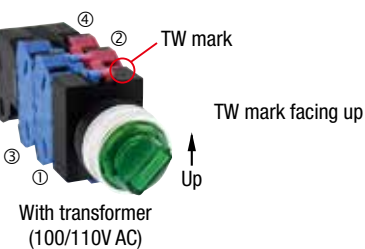
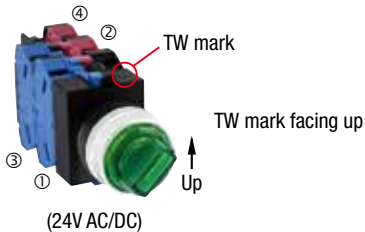

Dimensions

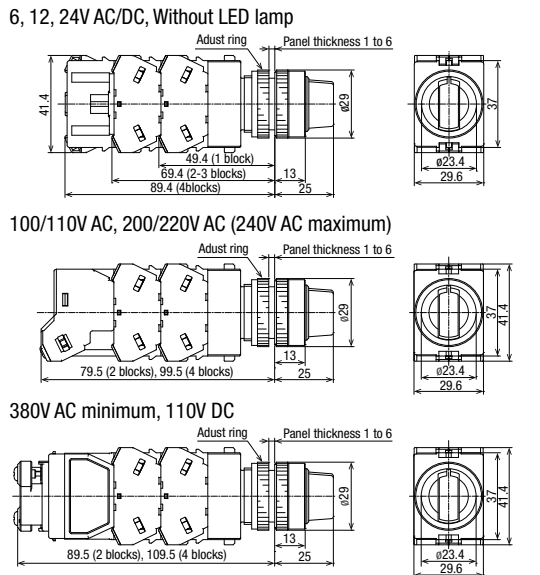

Terminal screw: M3.5
Integrated terminal cover

See B-248 for bottom view.

ø22 TW Series Selector Switch Contact Arrangement Chart

Selector Switch Contact Arrangement

90° 2-position

Contact Code	Circuit No.	Contact Block		Operator Operation and Circuit Availability									Operator Availability (*1)				
				Maintained 1 2			Spring return from right 1 2			Spring return from left 1 2							
		Mounting Position	Contact	Knob/ Lever	Key	Illuminated	Knob/ Lever	Key	Illuminated	Knob/ Lever	Key	Illuminated	Knob	Lever	Key	Illuminated	
				1	2	1	2	1	2	1	2	6V, 12V, 24V AC/DC				100/110V AC 200/220V AC	
10	—	①	NO		●		●	●				×	×	×	×	—	
		②	—	Dummy Block			Dummy Block			Dummy Block							
01	—	①	NC	●		●				●		×	×	×	×	—	
		②	—	Dummy Block			Dummy Block			Dummy Block							
11	—	①	NO		●		●	●				×	×	×	×	×	
		②	NC	●		●				●							
20	—	①	NO		●		●	●				×	×	×	×	×	
		②	NO		●		●	●									
02	—	①	NC	●		●				●		×	×	×	×	×	
		②	NC	●		●				●							
22	—	①	NO		●		●	●				×	×	×	×	×	
		②	NC	●		●				●							
		③	NO		●		●	●									
		④	NC	●		●				●							
31	107	①	NC	●		●				●		×	×	×	×	×	
		②	NO		●		●	●									
		③	NO		●		●	●									
		④	NO		●		●	●									
40	—	①	NO		●		●	●			×	×	×	×	×		
		②	NO		●		●	●									
		③	NO		●		●	●									
		④	NO		●		●	●									
2R	118	①	EM	—————			—————						×	×	×	×	×
		②	LB	—————			—————										
2R	168	①	EM							—————			×	×	×	×	×
		②	LB							—————							

- On the contact arrangement marked with ☆ in the table above (contact code: 2R), the rated current (load switching current) is reduced to a half of the related current of the contact block. The rated insulation voltage and the rated thermal current remain unchanged.
- For models with ☆, contacts may overlap when the operator is changed.

Contact Block Mounting Position

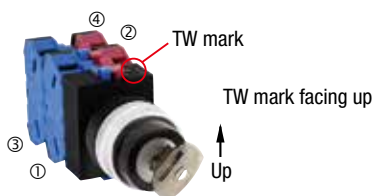

Ordering Information

ASW 2 L 31 - 107

- Circuit No.
- Contact Code
- Operator Type
Blank: Knob
L: Lever
K: Key
- No. of positions/operator operation
2: 2-position/maintained
21: 2-position/spring return from right
22: 2-position/spring return from left

45° 3-position <Maintained / Spring Return from Right / Spring Return from Left / Spring Return Two-way>

Contact Code	Circuit No.	Contact Block		Operator Operation			Circuit Availability			Operator Availability (*1)				
		Mounting Position	Contact	1	0	2	Knob/ Lever	Key	Illuminated	Knob	Lever	Key	Illuminated	
													6V, 12V, 24V AC/DC	100/110V AC 200/220V AC
11	202	①	NO	●	—	—	—	×	—	×	×	×	×	×
		②	NC	—	—	—	—	—	—	×	×	×	×	×
	203	①	NC	—	—	—	—	×	—	×	×	×	×	×
		②	NO	—	—	●	—	—	—	×	×	×	×	×
	303	①	NC	—	●	—	—	×	—	×	×	×	×	×
		②	NO	—	—	●	—	—	—	×	×	×	×	×
20	—	①	NO	●	—	—	×	—	×	×	×	×	×	
		②	NO	—	—	●	—	—	×	×	×	×	×	
02	—	①	NC	—	—	—	×	—	×	×	×	×	×	
		②	NC	—	—	—	×	—	×	×	×	×	×	
22	—	①	NO	●	—	—	×	—	×	×	×	×	×	
		②	NO	—	—	●	—	—	×	×	×	×	×	
		③	NC	—	—	—	—	×	—	×	×	×	×	
		④	NC	—	—	—	—	×	—	×	×	×	×	
	210	①	NC	—	—	—	—	×	—	×	×	×	×	
		②	NO	—	—	●	—	—	×	×	×	×	×	
		③	NC	—	—	—	—	×	—	×	×	×	×	
		④	NO	—	—	●	—	—	×	×	×	×	×	
	310	①	NC	—	●	—	—	×	—	×	×	×	×	
		②	NO	—	—	●	—	—	×	×	×	×	×	
		③	NC	—	●	—	—	×	—	×	×	×	×	
		④	NO	—	—	●	—	—	×	×	×	×	×	
31	207	①	NC	—	—	—	×	—	×	×	×	×	×	
		②	NO	—	—	●	—	—	×	×	×	×	×	
		③	NO	●	—	—	—	×	—	×	×	×	×	
		④	NO	—	—	●	—	—	×	×	×	×	×	
40	—	①	NO	●	—	—	×	—	×	×	×	×	×	
		②	NO	—	—	●	—	—	×	×	×	×	×	
		③	NO	●	—	—	—	×	—	×	×	×	×	
		④	NO	—	—	●	—	—	×	×	×	×	×	
04	—	①	NC	—	—	—	×	—	×	×	×	×	×	
		②	NC	—	—	—	×	—	×	×	×	×	×	
		③	NC	—	—	—	×	—	×	×	×	×	×	
		④	NC	—	—	—	×	—	×	×	×	×	×	

- APEM
- Switches & Pilot Lights
- Control Boxes
- Emergency Stop Switches
- Enabling Switches
- Safety Products
- Explosion Proof
- Terminal Blocks
- Relays & Sockets
- Circuit Protectors
- Power Supplies
- LED Illumination
- Controllers
- Operator Interfaces
- Sensors
- AUTO-ID
- Flush Silhouette
- ø16
- ø22
- ø30
- Miniature
- Pilot Lights

Contact Block Mounting Position

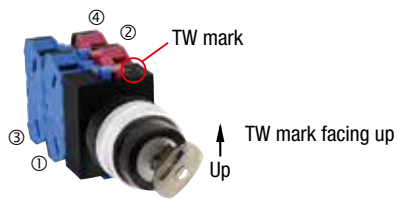

Ordering Information

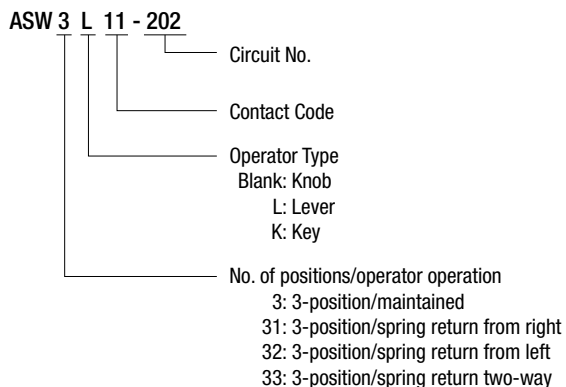

- HW
- TW
- YW

ø22 TW Series Selector Switch Contact Arrangement Chart

45° 3-position (Maintained)

Contact Code	Circuit No.	Contact Block		Operator Operation and Circuit			Operator Availability				
				Maintained			Knob	Lever	Key	Illuminated	
				1	0	2				6, 12, 24V AC/DC	100/110V AC 200/220V AC
Mounting Position	Contact	1	0	2							
3S ☆	243	①	NO	●			×	×	×	×	—
		②	NO			●					
		③	NC		●						
		④	—	Dummy Block							
4S ☆	234	①	NO	●			×	×	×	×	×
		②	LB	—————							
		③	NC		●						
		④	LB	—————							
4S ☆	237	①	NO	●			×	×	×	×	×
		②	NO			●					
		③	NC		●						
		④	NO			●					
4S ☆	240	①	LB	—————			×	×	×	×	×
		②	LB	—————							
		③	NC		●						
		④	NO			●					

Ordering Information

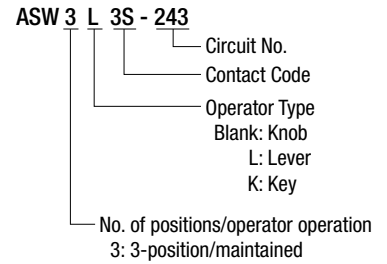

45° 4-position (Maintained)

Contact Code	Circuit No.	Contact Block		Operator Operation and Circuit				Operator Availability	
				Maintained				Knob	Lever
				1	2	3	4		
Mounting Position	Contact	1	2	3	4				
4S ☆	407	①	LB	—————				×	×
		②	NC		●				
		③	NC			●			
		④	NO				●		
4S ☆	411	①	NO	●				×	×
		②	NC		●				
		③	NC			●			
		④	NO				●		

Ordering Information

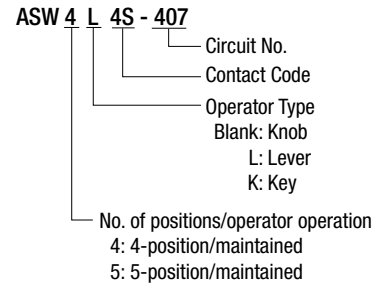

30° 5-position (Maintained)

Contact Code	Circuit No.	Contact Block		Operator Operation and Circuit					Operator Availability	
				Maintained					Knob	Lever
				1	2	3	4	5		
Mounting Position	Contact	1	2	3	4	5				
4S ☆	501	①	NO	●					×	×
		②	NC		●					
		③	NC				●			
		④	NO					●		

- On the contact arrangement marked with ☆ in the table above (contact code: 3S, 4S), the rated current (load switching current) is reduced to a half of the related current of the contact block. The rated insulation voltage and the rated thermal current remain unchanged.
- For models with ☆, contacts may overlap when the operator is changed.

Contact Block Mounting Position

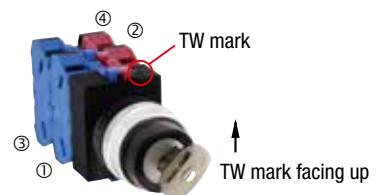

APEM

Switches & Pilot Lights

Control Boxes

Emergency Stop Switches

Enabling Switches

Safety Products

Explosion Proof

Terminal Blocks

Relays & Sockets

Circuit Protectors

Power Supplies

LED Illumination

Controllers

Operator Interfaces

Sensors

AUTO-ID

Flush Silhouette

ø16

ø22

ø30

Miniature

Pilot Lights

HW

TW

YW

Nameplates

All dimensions in mm.

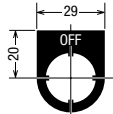
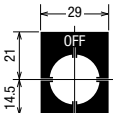
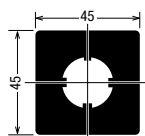
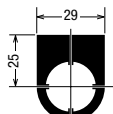
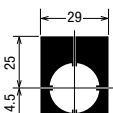
Shape	Legend	Material	Part No.	Ordering No.	Package Quantity
NWA  0.8 mm thick	Blank	Aluminum (black) (Legend: white)	NWA-0	NWA-0	1
	With Legend			NWA-□	NWA-□PN10
NWAQ  0.8 mm thick	Blank	Aluminum (black) (Legend: white)	NWAQ-0	NWAQ-0	1
	With Legend			NWAQ-□	NWAQ-□PN10
NWAS  0.8 mm thick	Blank	Aluminum (black)	NWAS-0	NWAS-0	1
					NWAS-0PN10
NWAL  0.8 mm thick	Blank	Aluminum (black)	NWAL-0	NWAL-0	1
					NWAL-0PN10
NWAQL  0.8 mm thick	Blank	Aluminum (black)	NWAQL-0	NWAQL-0	1
					NWAQL-0PN10

- Specify a legend code in place of □ in the Ordering No.
- The nameplates are used for TW series only.

Legends

Code	Legend
1	ON
2	OFF
3	START
4	STOP
31	OFF ON
35	HAND AUTO
53	HAND OFF AUTO









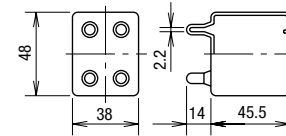
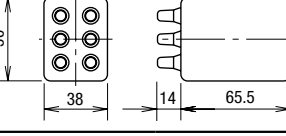

Accessories

All dimensions in mm.

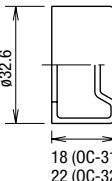
Shape	Material	Part No.	Ordering No.	Package Quantity	Dimensions
	Nitril rubber	OR-14	OR-14	1	<ul style="list-style-type: none"> Used to tighten the round bezel when installing the TW switch onto a panel.  <p>For ø25 series For ø22 series</p>
	Nitril rubber	OR-55	OR-55	1	<ul style="list-style-type: none"> Used to install and remove the LED lamps. See B-266 for how to install. Ⓐ : BA9S 
	Zinc-plated metal Nitril rubber	TW-KC1	TW-KC1	1	<ul style="list-style-type: none"> Used to remove the transformer, to install/remove the waterproof lens and pilot light lens. Can also be used to determine panel thickness (1, 1.6, 2, 2.3, 3.2, 5 mm). 
	Metal (nickel-plated)	TW-KQ2	TW-KQ2	1	<ul style="list-style-type: none"> Used to tighten the locking nuts inside of the square bezel. This tool can be inserted into the OR-14 locking ring wrench. 
	Metal (zinc-plated)	OGL-31	OGL-31PN10	10	<ul style="list-style-type: none"> Used to prevent the operator from turning. Generally used when using no nameplates on selector switches. Installed on the front of panel. 
	Nitril rubber (black)	OB-31	OB-31PN05	5	<ul style="list-style-type: none"> Used to plug unused ø22.2mm mounting holes. Degree of protection: IP65 (round mounting hole) IP40 (with anti-rotation function) 
	Plug: chrome-plated zinc diecast Locking ring: polyamide	LW9Z-BM	LW9Z-BM	1	<ul style="list-style-type: none"> Used to plug the unused ø22.2 mm mounting holes. Degree of protection: IP66 (round hole) IP40 (with anti-rotation function) Tightening torque: 1.2 N·m 
	Polyamide (black)	LW9Z-BP1	LW9Z-BP1	1	<ul style="list-style-type: none"> Used to plug the unused ø22.2 mm mounting holes. Degree of protection: IP65 Tightening torque: 2.0 N·m 
	Polyamide	HW-VU1	HW-VU1PN10	10	<ul style="list-style-type: none"> Used to prevent contact between adjacent lead wires when units are mounted closely (see B-266 for details). Barriers should always be used in close mounting. 

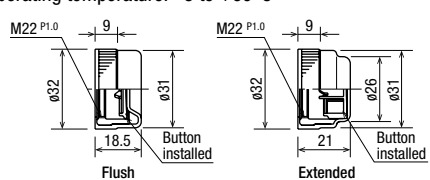
Accessories

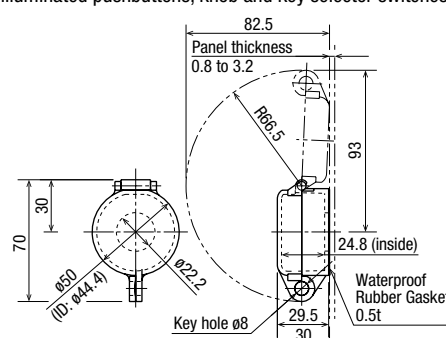
All dimensions in mm.

Shape	Material	Part No.	Ordering No.	Packaging Quantity	Description
 <p>① For 1 layer of contact blocks (2 contact blocks)</p> <p>② For 2 layers of contact blocks (4 contact blocks)</p>	Nitril rubber (black)	OCW-99	OCW-99	1	<ul style="list-style-type: none"> Oiltight rubber boot used for the contact blocks of pushbuttons and selector switches. Temperature range: -5 to +60°C  
		OCW-299	OCW-299	1	
 <p>For flush pushbuttons</p> <p>For extended pushbuttons</p>	Rubber (EPDM)	OC-31	OC-31	1	<ul style="list-style-type: none"> Used to cover and protect pushbuttons where units are subject to water splash. Not suitable for outdoor use or where the units are subject to oil splash. 
		OC-32	OC-32	1	
 <p>① For flush pushbuttons</p> <p>② For extended pushbuttons</p>	Nitril rubber	OCW-10*	OCW-10*	1	<ul style="list-style-type: none"> Used to cover the bezels to enhance waterproof characteristics of pushbuttons. Button is installed in the cover. Remove the button from the pushbutton before using the button cover. Make sure to align the button with the axis on the switch. Using the button cover enhances oilproof characteristics. Specify a color code in place of * in Ordering No. B (black), G (green), R (red), Y (yellow) Operating temperature: -5 to +60°C 
		OCW-11*	OCW-11*	1	
	Polyarylate (gasket: nitril rubber)	HW9Z-KL1	HW9Z-KL1*	1	<ul style="list-style-type: none"> Used to protect momentary and maintained pushbuttons, illuminated pushbuttons, knob and key selector switches. 
	Metal (steel)	HS9Z-PC22	HS9Z-PC22	1	Used for ASW□K key selector switches.

APEM

Switches & Pilot Lights

Control Boxes

Emergency Stop Switches

Enabling Switches

Safety Products

Explosion Proof

Terminal Blocks

Relays & Sockets

Circuit Protectors

Power Supplies

LED Illumination

Controllers

Operator Interfaces

Sensors

AUTO-ID

Flush Silhouette

ø16

ø22

ø30

Miniature

Pilot Lights

HW







TW

YW

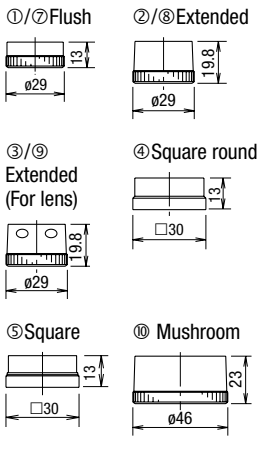

Accessories

All dimensions in mm.

Shape	Material	Part No.	Ordering No.	Packaging Quantity	Remarks/Dimensions		
	Nitril rubber	HW9Z-A25	HW9Z-25PN05	5	<ul style="list-style-type: none"> Used to install the TW series units into ø25 mm mounting holes. IP65 Cannot be used with anti-rotation and nameplate. Mounting panel thickness: 1.2 to 5.5 mm See B-265 for details. 		
Plastic Bezel 	Polyacetal (black)	① Flush	AW-RP1B	AW-RP1BPN05	5		
		② Extended	AW-FP1B	AW-FP1B	1		
		③ Extended (for illuminated pushbuttons)	AW-FP2B	AW-FP2B	1		
		④ Square round (for round buttons)	AW-H1B	AW-H1B	1		Supplied with base plate and locking ring
		⑤ Square	AW-Q1B	AW-Q1B	1		
Aluminum Bezel 	Aluminum	⑦ Flush	AW-R1	AW-R1PN05	5	Aluminum color	
		⑧ Extended	AW-R1B	AW-R1B	1		Black
		⑨ Extended (illuminated)	AW-F1	AW-F1	1		Aluminum color
		⑩ Mushroom	AW-F2	AW-F2	1		Aluminum color
			AW-G4	AW-G4	1		Aluminum color
Selector Operator 	Polyacetal	① Knob	ASWHHY-*	ASWHHY-*PN02	2	Specify a color code in place * in Ordering No. B (black), G (green), R (red) ø23.4, H19	
		② Lever	ASWHHL-*	ASWHHL-*PN02	2	Specify a color code in place * in Ordering No. B (black), G (green), R (red) ø23.4, H19	
		③ Round	ASWHHM-B	ASWHHM-BPN02	2	Black only, ø23.4, H18.5	
	Polyacetal	④ Color Insert	TW-HC1*	TW-HC1*PN05	5	Specify a color code in place * in Ordering No. B (black), G (green), R (red), Y (yellow), S (blue), W (white) W21, H18, D5	
		AS resin O-ring: nitril rubber	⑤ Illuminated Selector	ASLWDDY-*	ASLWDDY-*	1	Specify a color code in place * in Ordering No. A (amber), Y (yellow), W (white) ø20.6, H19.6
AS resin O-ring: nitril rubber	ASLWLDY-*		ASLWLDY-*	1	Specify a color code in place * in Ordering No. R (red), G (green), S (blue) ø20.6, H19.6		
	Metal (zinc coated steel)	OLW-C	OLW-C	1	Used to protect flush pushbuttons from inadvertent operation. Weight: 36.5g 		

APEM

Switches & Pilot Lights

Control Boxes

Emergency Stop Switches

Enabling Switches

Safety Products

Explosion Proof

Terminal Blocks

Relays & Sockets

Circuit Protectors

Power Supplies

LED Illumination

Controllers

Operator Interfaces

Sensors

AUTO-ID

Flush Silhouette

ø16

ø22

ø30

Miniature

Pilot Lights







HW

TW

YW

Maintenance Parts

All dimensions in mm.







Shape	Material	Part No.	Ordering No.	Packaging Quantity	Color Code	
Lens (for pilot lights) 	AS resin ①ø23.6, H12.7 ②ø23.6, H12.7 ③ø23.6, H20.0 ④□24.7, H12.3	APW1L-*	APW1L-***PN05	5	R (red), G (green), S (blue)	
		APW1LD-*	APW1LD-***PN05		A (amber), Y (yellow), W (white)	
		APW11LN-*	APW11LN-***PN05		R (red), G (green), S (blue), C (clear) (*1)	
		APW11LD-*	APW11LD-***PN05		A (amber), Y (yellow),	
		APW2L-*	APW2L-***PN05		R (red), G (green), S (blue)	
		APW2LD-*	APW2LD-***PN05		A (amber), Y (yellow), W (white)	
		APQW11L-*	APQW11L-***PN05		R (red), G (green), S (blue), C (clear) (*1)	
		APQW11LD-*	APQW11LD-***PN05		A (amber), Y (yellow),	
Lens (for illuminated pushbuttons) 	AS resin ①ø23.6, H8.6 ②ø23.6, H8.6 ③□24.8, H9.6	ALW2L-*	ALW2L-***PN05	5	R (red), G (green), S (blue)	
		ALW2LD-*	ALW2LD-***PN05		A (amber), Y (yellow), W (white)	
		ALW21L-*	ALW21L-***PN05		R (red), G (green), S (blue), C (clear) (*1)	
		ALW21LD-*	ALW21LD-***PN05		A (amber), Y (yellow),	
		ALQW21L-*	ALQW21L-***PN05		R (red), G (green), S (blue), C (clear) (*1)	
	④ø29 Mushroom lens ⑤ø40 Mushroom lens	④ø29.0/ø23.6 H12.7	AVLW3L-R	AVLW3L-RPN02	2	Marking type
			AVLW31L-R	AVLW31L-RPN02		
			AVLW4L-R	AVLW4L-RPN02		
		⑤ø40.0/ø23.6 H12.5	AVLW41L-R	AVLW41L-RPN02		
Button 	Polyacetal ①ø23.6, H3 (4.8) ②ø23.6, H9.5 (11.5) ③□24.8, H1.5 (3.0) ④□24.8, H8 (9.5) ⑤ø29 H12.5 ⑥ø40 H12.5 ⑦ø29.0/ø23.6, H12.7 ⑧ø40.0/ø23.6, H12.5 ⑨ø40/ø23.6, H20.2 ⑩ø40/ø23.6, H14	ABW1B-*	ABW1B-***PN05	5	B (black), G (green), R (red), Y (yellow), S (blue), W (white)	
		ABW2B-*	ABW2B-***PN05			
		ABQW1B-*	ABQW1B-***PN05			
		ABQW2B-*	ABQW2B-***PN05			
		⑤ø29 Mushroom button unit ⑥ø40 Mushroom button unit ⑦ø29 Mushroom pushlock turn reset ⑧ø40 Mushroom pushlock turn reset ⑨ø40 Mushroom push pull ⑩ø40 Mushroom Pushlock Key Reset	ABW3B-*	ABW3B-***PN02	2	R (red), Y (yellow)
			ABW4B-*	ABW4B-***PN02		
			AVW3B-*	AVW3B-***PN02		
			AVW4B-*	AVW4B-***PN02		
			AYW4B-*	AYW4B-***PN02		
			AXW4B-R	AXW4B-RPN02		
Marking Plate (for pilot lights) 	Acrylic ①ø17.2, H8.5 ②□22.0, H2.6	APW2B	APW2BPN05	5	White See B-265 for dimensions.	
		APQW1B	APQW1BPN05			
Marking Plate (for illuminated pushbuttons) 	Acrylic ①ø17.0, H6.4 ②□21.0, H4.4 ③ø15.7, H3.4	ALW2B	ALW2BPN05	5	White See B-265 for dimensions.	
		ALQW2B	ALQW2BPN05			
		ALW3B	ALW3BPN05			
Waterproof Lens 	Acrylic ①ø21.8, H7.1 ②ø20.6, H5.6	APW00LN	APW00LNPN05	5		
		APW00L	APW00LPN05			

*1) Use a C (clear) lens for PW (pure white) illumination.

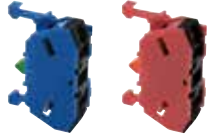

Maintenance Parts

All dimensions in mm.

Shape	Specification	Part No.	Ordering No.	Packaging Quantity	Remarks
 Contact Block HW-U Weight: 11g (approx.)	1NO	HW-U10	HW-U10	1	Housing color: Blue Push rod color: Green MAU has gold contacts
		HW-U10-MAU	HW-U10-MAU		
	1NC	HW-U01	HW-U01	1	Housing color: Reddish purple Push rod color: Red MAU has gold contacts
		HW-U01-MAU	HW-U01-MAU		
	EM contact (early make contact)	HW-U10R	HW-U10R	1	Housing color: Blue Push rod color: Black MAU has gold contacts
HW-U10R-MAU		HW-U10R-MAU			
LB (late break contact)	HW-U01R	HW-U01R	1	Housing color: Reddish purple Push rod color: White MAU has gold contacts	
	HW-U01R-MAU	HW-U01R-MAU			
 Dummy Block Weight: 3.5g (approx.)	Polyamide	HW-DB	HW-DBPN10	10	For HW-U contact blocks Used when the total number of contact blocks and full voltage adapters is odd.
 Full Voltage Adapter For illuminated unit (*1) Weight: 12g (approx.)	Polyamide	HW-GA1N	HW-GA1NPN02	2	Applicable model: Illuminated pushbuttons Illuminated selector switches Applicable load (LED lamp) LSTD-6 (6V AC/DC) LSTD-1 (12V AC/DC) LSTD-2 (24V AC/DC)
 Transformer Unit (*1) Weight: 65g (approx.)	100/110V AC	HW-T16	HW-T16	1	Applicable model: Pilot lights Illuminated pushbuttons Illuminated selector switches Applicable load (LED lamp) LSTD-6 (6V AC/DC)
	200/220V AC	HW-T26	HW-T26	1	
 Spare Key Length 39 Width 19.7 Thickness 1.8	Metal (nickel-plated brass)	TW-SK-0	TW-SK-0PN02	2	Applicable model: Key selector switches Pushlock key reset
 Contact Block Plug	Polyamide	HW9Z-CBPL	HW9Z-CBPLPN10	10	Used to plug the hole in the center of contact block.

*1) For use as maintenance parts. Do not use for expansion or remodelling purposes.

TW Series LED Lamps

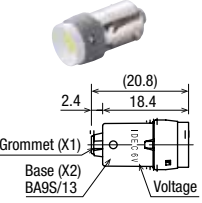
Shape/Dimensions	Rated Voltage	Current Draw		Part No.	Ordering No.	Color Code	Package Quantity	Base
		DC	AC					
 Grommet (X1) Base (X2) BA9S/13 Voltage	6V AC/DC	7 mA (R, A, W) 5.5 mA (G, PW) 4.5 mA (S)	8 mA (except S) 7 mA (S)	LSTD-6	LSTD-6*	R, G, A, W, S, PW	1	BA9S/13
		LSTD-6*PN10	R, G, A, W, S, PW		10			
	12V AC/DC	10 mA (except S) 8 mA (S)	11 mA (except S) 9 mA (S)	LSTD-1	LSTD-1*	R, G, A, W, S, PW	1	
		LSTD-1*PN10	R, G, A, W, S, PW		10			
	24V AC/DC	10 mA (except S) 8 mA (S)	11 mA (except S) 9 mA (S)	LSTD-2	LSTD-2*	R, G, A, W, S, PW	1	
		LSTD-2*PN10	R, G, A, W, S, PW		10			

- Specify a color code in place of * in Ordering No. R (red), G (green), A (amber), W (white), S (blue), PW (pure white)
- Use a PW (pure white) LED for Y (yellow) illumination.

LED lamps for replacing incandescent lamps



- Use the following replacement LED lamps to replace incandescent lamps.
- See TW series LED lamps shown above for ordering.
- LED lamps may have different brightness/color hue compared with incandescent lamps.

Incandescent Lamp				
Model (mm)	Part No.	Operating Voltage	Lamp Rating	Base
 Bulb: ø11 Length: 23	LS-6	6V AC/DC	1W (6V)	BA9S/13
	LS-8	12V AC/DC	1W (18V)	
	LS-2	18V AC/DC	1W (24V)	
	LS-3	24V AC/DC	1W (30V)	

Replacement LED Lamp			
Part No.	Color Code	Operating Voltage	Base
LSTD-6*	R, G, A, S, PW	6V AC/DC	BA9S/13
LSTD-1*		12V AC/DC	
LSTD-2*		24V AC/DC	
LSTD-2*		24V AC/DC	

- Specify a color code in place of * in Part No. R (red), G (green), A (amber), S (blue), PW (pure white)
- Use a PW (pure white) LED lamp for Y (yellow) illumination.

Transformer

Shape	Rated Voltage	Operating Voltage Range	Ordering No.	Applicable Load
	100/110V AC	100/110V AC ±10%	TWR516	LSTD-6* (6V AC/DC, LED lamp)
	200/220V AC	200/220V AC ±10%	TWR526	
	400/440V AC	400/440V AC ±10%	TWR546	
 CE	100/110V AC	100/110V AC ±10%	TWR512	LSTD-2* (24V AC/DC, LED lamp)
	200/220V AC	200/220V AC ±10%	TWR522	
	400/440V AC	400/440V AC ±10%	TWR542	

- Terminal cover (TWR-VL3) is installed on transformers as standard.
- Transformer is installed to one TW series unit.



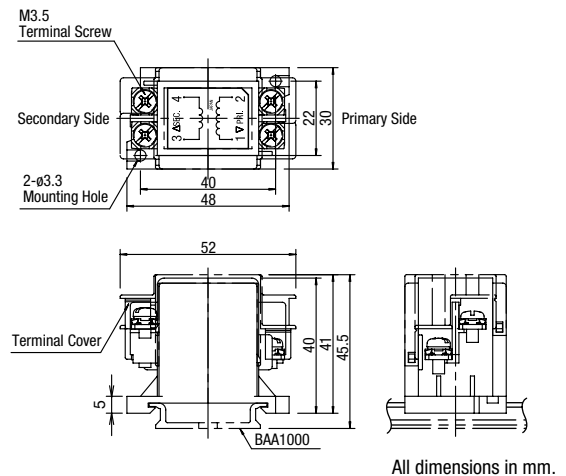

Specifications

Part No.	TWR5□6	TWR5□2
Operating Voltage	100/110V AC, 200/220V AC, 400/440V AC (50/60Hz)	
Current Draw	2.4VA	
Rated Insulation Voltage	600V	
Insulation Resistance	100MΩ minimum (500V DC megger)	
Operating Temperature	-30 to +60°C (no freezing)	
Operating Humidity	35 to 85% RH (no condensation)	
Storage Temperature	-40 to +80°C (no freezing)	
Vibration Resistance	Damage limits: 30Hz, amplitude 1.5 mm Operating extremes: 5 to 55Hz, amplitude 0.5 mm	
Shock Resistance	Damage limits: 1,000 m/s ² Operating extremes: 100 m/s ²	
Dielectric Strength	2500V AC, 1 minute	
Terminal Screw	M3.5	
Applicable Wire	2mm ² maximum, 2 wires maximum	
Weight (approx.)	87g	

Dimensions

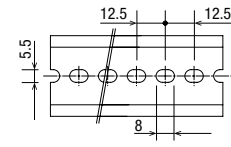

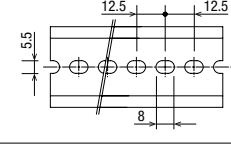
Accessories

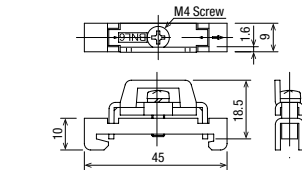
Shape	Material	Part No.	Ordering No.	Package Quantity	Dimensions (mm)
 Weight: 200g approx.	Aluminum Length: 1000mm	BAA1000	BAA1000PN10	10	
 Weight: 320g approx.	Steel Length: 1000mm	BAP1000	BAP1000PN10	10	
 Weight: 15g approx.	Metal (zinc-plated steel) Applicable rail: BAA1000 BAP1000	BNL6	BNL6PN10	10	

- See **H-071** for DIN rail products.

Safety Precautions

- Turn off the power to the TW series switches & pilot lights before starting installation, removal, wiring, maintenance, and starting installation, removing, wiring, maintenance, and inspection of the products. Failure to turn power off may cause electrical shocks or fire hazard.
- To avoid a burn on your hand, use the lamp holder tool when replacing lamps.
- For wiring, use wires of a proper size to meet the voltage and current requirements. Tighten the terminal screws to the recommended tightening torque (see **B-268**). Failure to tighten terminal screws may cause overheat and fire.
- When using a commercially available lamp, choose a lamp with rated voltage 5 to 30V AC/DC and 1W maximum, and with the same base and shape. Make sure of correct operation before installation. The operation of illuminated pushbutton switches cannot be guaranteed when a commercially available lamp is used.

Operating Instructions

Panel Mounting

Panel thickness adjustment ring is used for the TW series. To attach the TW series to the panel, follow the procedures below.

Panel Thickness Adjustment

See "Adjusting Panel Thickness" below.



Panel thickness adjustment ring

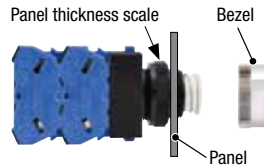

Panel thickness scale

Bezel

Panel

Mounting the Unit onto the Panel

After adjusting the panel thickness, attach the unit to the panel with the panel thickness scale facing up, and attach the bezel. See "2. Installing the Round/Square Bezel" for installing the bezel.

Attach a nameplate before installing the bezel.

Attaching the Button, Lens, and Knob

See "3. Installing Buttons, Lenses, and Operators."

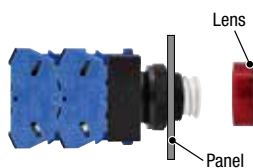

Lens

Panel

1. Adjusting Panel Thickness

The panel thickness ring provides adjustment from 1 to 6 mm in 0.1-mm increments. Set the panel thickness to line A. Rotate the ring until the desired thickness indication around the periphery is aligned with line A, as shown below.

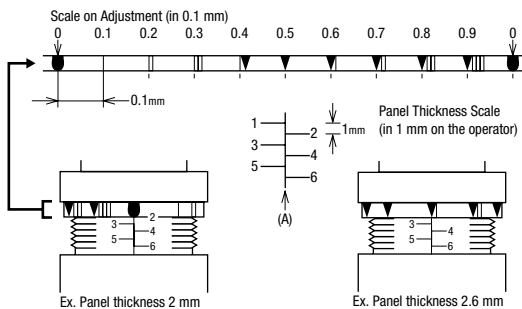

Note: When a nameplate or an anti-rotation ring is used, add 0.8 mm to the panel thickness.
Total thickness = Panel thickness + 0.8 mm (nameplate or anti-rotation ring thickness)

When the adjustment value is 1, 1.6, 2, 2.3, 3.2, or 3.5 mm.

Panel thickness can be adjusted easily to the values shown below by inserting the contact block removal tool between the adjustment ring and base.

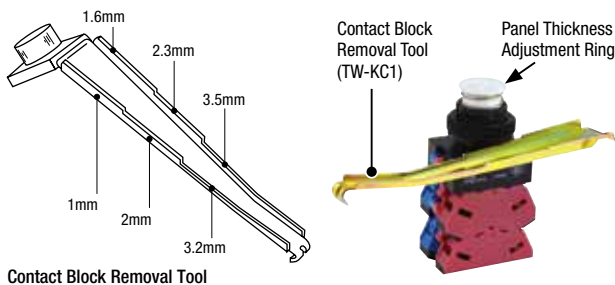

Contact Block Removal Tool

2. Installing the Round/Square Bezel

Round bezel

All round bezels are screw-in type. Be sure to use the locking ring wrench (OR-14) to tighten the bezel to a torque of 2.0 N-m.



Use side B when mounting the units closely.

Square bezel

Install the TW series on the panel from the back, and follow the instructions below.

- (1) Insert the base plate from the front.
- (2) Insert the lock nut. For easy installation, use the nut locking wrench.
- (3) Mount the square bezel. The bezel will use the nut locking wrench.

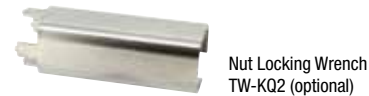

Nut Locking Wrench TW-KQ2 (optional)

Lock nut can be installed easily by using the nut locking wrench (TW-KQ2). Tightening torque is 2.0 N-m.

3. Installing Buttons, Lenses, and Operators

Pushbuttons

Flush/Extended/Square

Push in the button to install.



Mushroom

Button has threads. Turn clockwise to install the button.



Illuminated Pushbutton/Pilot Light Lens

Extended

Lens has threads. Turn clockwise to install the button.



Round/Flush

Lens has threads. Turn clockwise to install the button.



APEM
Switches & Pilot Lights
Control Boxes
Emergency Stop Switches
Enabling Switches
Safety Products
Explosion Proof
Terminal Blocks
Relays & Sockets
Circuit Protectors
Power Supplies
LED Illumination
Controllers
Operator Interfaces
Sensors
AUTO-ID

Flush Silhouette
ø16
ø22
ø30
Miniature
Pilot Lights

HW
TW
YW

Operating Instructions

Installing the Operator on Selector Switches

(1) Install the switch with TW marking facing upward, so that the operator can be installed on the switch in the correct direction.

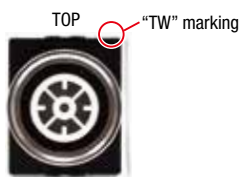

(2) On non-illuminated models, install the color insert in the middle of operator. The color insert also serves to retain the operator.



(3) On illuminated models, align the operator with the switch by confirming the TOP marking on the switch and also the switch operation. Then press in the operator into the switch.



Installation of Selector Operators

The shaft of each non-illuminated selector switch has a recess to identify the direction to install the operator. Align the operator with the recess and press in the operator. Press a color insert (non-illuminated) into the operator (illuminated selector switches do not have a recess on the shaft).

Non-illuminated Selector Switches

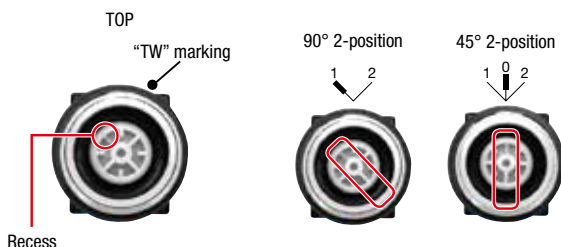

In addition to the standard positions shown below, the non-illuminated operators can be installed 45° intervals.

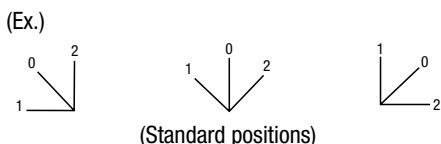

Illuminated Selector Switches



In addition to the standard positions shown below, the non-illuminated operators can be installed 45° intervals.

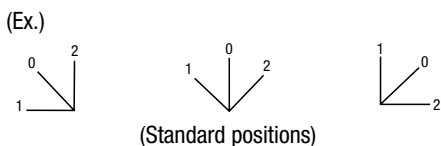

Removing the Buttons and Lenses

Pushbuttons

Flush/Extended/Square

Insert a flat screwdriver between the button and the bezel to remove the button



Mushroom

The button has threads. Turn the button counterclockwise to remove.



Illuminated Pushbutton/Pilot Light Lens

Extended

The lens has threads. Turn the lens counterclockwise to remove.



Round/Flush

The lens has threads. Turn the lens counterclockwise to remove.



Square Lens

Insert a flat screwdriver between the lens and bezel, and tilt the screwdriver to remove the lens.

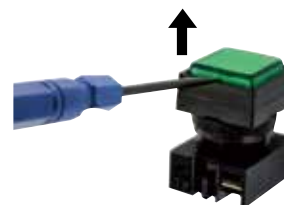

Notes

- The square lens of the illuminated pushbutton cannot be used without waterproof lens. Always use the waterproof lens.
- Be sure to use the marking plate even when marking is not required.

Non-illuminated Selector Switches



Insert a flat screwdriver with tip width 4.5 mm maximum into the recess under the color insert. Turn the screwdriver to push out the insert from the operator.



Pull out the operator sideways as shown in the left photo to remove the operator.

Illuminated Selector Switches



Insert a flat screwdriver with tip width 5 mm maximum into the recess opposite from the color insert and tilt. The operator is displaced slightly.

Operating Instructions

Removing the Contact Blocks/Full Voltage Adapters

Insert a flat screwdriver (4 to 6 mm) into the snap-fit latches of the contact block or full voltage adapter and lift to remove.

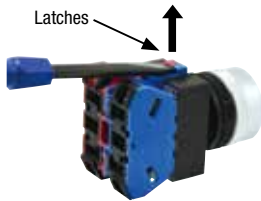

Latches

- Make sure to lift both latches. Contact blocks cannot be removed by lifting one latch only.
- Do not apply excessive force to the latches, otherwise damage may be caused.

Transformer Units and DC-DC Converters

Insert the end of the contact block removal tool (TW-KC1) into the snap-fit latch of the transformer units or DC-DC converter and pull the tool forward.

The contact block removable tool cannot be used to remove the contact blocks (HW-U), full voltage adapters (HW-GA1N), or dummy blocks (HW-DB).

Illuminated Pushbuttons/Illuminated Selector Switches

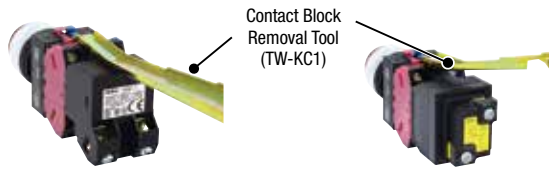

Contact Block Removal Tool (TW-KC1)

Pilot Lights

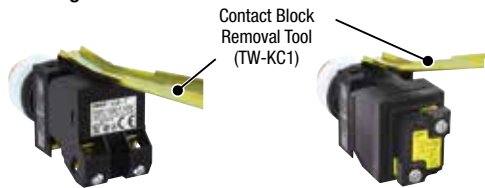

Contact Block Removal Tool (TW-KC1)

Notes on Replacing Units

When replacing parts (contact block, dummy block, full voltage adapter, transformer) for maintenance, make sure to install the parts to the original position. Otherwise proper operation cannot be guaranteed.

Using a Ring Adapter

• HW9Z-A25

Install the ring adapter between the HW series unit and panel. Make sure that the side with ridges face the panel.



Nitril Rubber

Dimensions

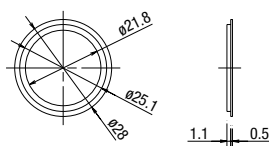

Installation

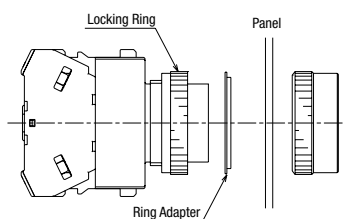

Panel Cut-out

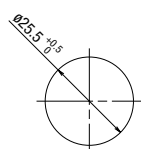

Marking Plate

• Round Pilot Lights (Marking Type)

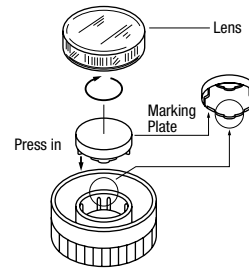

• Square Pilot Lights (Marking Type)

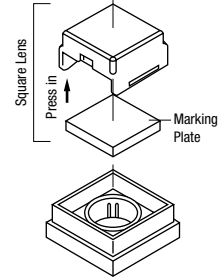

• Square Illuminated Pushbuttons

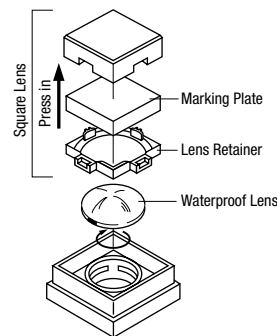

Marking Plate Engraving Area

Marking is possible on all square lens. To engrave, take out the marking plate inside the lens.

Round	Round (ø29/ø40)	Square (Pilot Light)	Square (Illuminated Pushbutton)

Note: The depth of the engraving must be within 0.5 mm.

Removing the Marking Plate

• Pilot Lights

Insert the screwdriver into the recess of the lens.

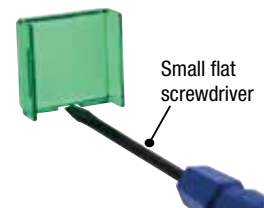

Small flat screwdriver

APEM

Switches & Pilot Lights

Control Boxes

Emergency Stop Switches

Enabling Switches

Safety Products

Explosion Proof

Terminal Blocks

Relays & Sockets

Circuit Protectors

Power Supplies

LED Illumination

Controllers

Operator Interfaces

Sensors

AUTO-ID

Flush Silhouette

ø16

ø22

ø30

Miniature

Pilot Lights

HW

TW

YW

Operating Instructions

Removing the Marking Plate

• Illuminated Pushbuttons

Remove the lens retainer by inserting a small flat screwdriver into a recess with a projection on the lens, and tilt lightly. Turn over the lens to remove the marking plate. Lightly tap the lens on a flat surface if necessary.

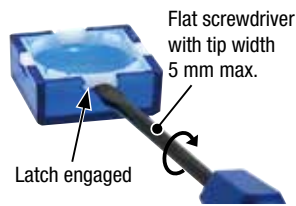

Installing the Lens Retainer

Install the marking plate into the lens, with flat surface facing the lens. Then install the lens retainer into the lens, by fitting a projection of the lens retainer into the recess with projection as shown at right.

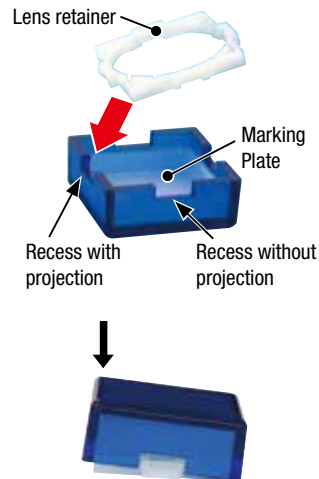

Turn over and press as shown at right so that the lens retainer is installed securely.

⚠ Notes

The square lens of the illuminated pushbutton cannot be used without waterproof lens. Always use the waterproof lens.

Be sure to use the marking plate even when it is not engraved.

• Installing Round Lens and Waterproof Lens

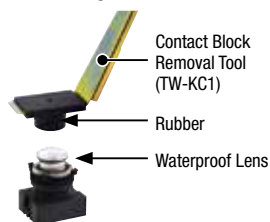

When installing or removing round lens of pilot lights and illuminated pushbuttons and waterproof lens of square pilot lights and illuminated pushbuttons, press the rubber part of the contact block removal tool onto the lens or waterproof lens for secure tightening and easy removal.

Replacement of LED Lamps

Lamps can be replaced by using the lamp holder tool (OR-55) from the front of the panel. (See B-257 for lamp holder tool.)

• How to Remove

To remove, slip the lamp holder tool onto the lamp head lightly. Then push slightly, and turn the lamp holder tool counterclockwise.



• How to Install

To install, insert the lamp head into the lamp holder tool. Place the two pins on the lamp base to the grooves in the lamp socket. Inset the lamp and turn it clockwise.

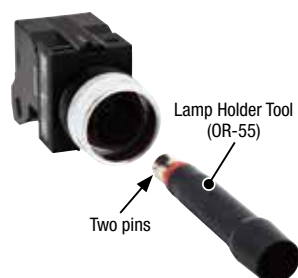

Selector Switches

Turn the operator such as knob, lever, and key to each position accurately. Releasing halfway may cause the operator to return to the former position, or to get stuck between. On spring return two-way types, the center of operators may be misaligned slightly.

Key Selector Switches

Insert the key completely before turning. Failure to do so may cause failures.

Collective Mounting

When mounting the units closely in a horizontal row on 30-mm centers, use optional barriers (HW-VU1) to prevent interconnection between adjoining terminals. The barriers can be attached simply by pressing them onto the sides of contact blocks.

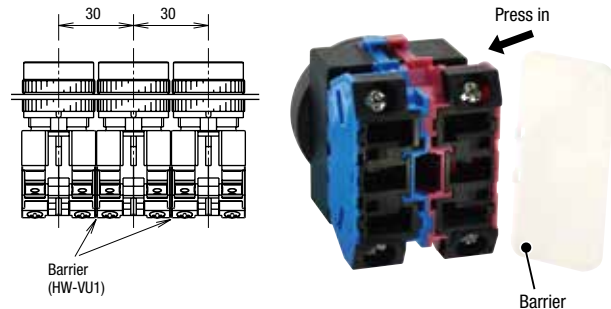

- Use a barrier (HW-VU1) between the contact blocks.
- Sufficient insulation distance cannot be obtained if barriers are not installed, or when other barriers such as HW-VG1 is used.

• Notes on Wiring Transformer Type Units

When using transformer type illuminated TW series of 240V AC maximum closely in a horizontal row on 30 mm centers, insert straight the solid wires or stranded wires into inside of the terminal screw on the transformer (see figure below) to prevent short circuit between adjoining terminals.

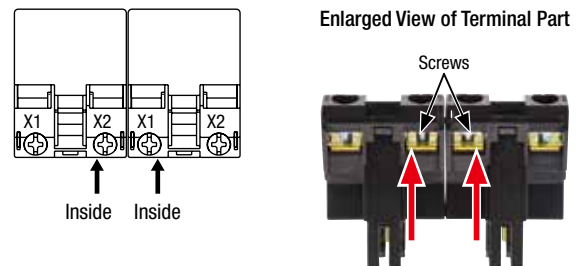

When using transformer type pilot lights closely mounted in horizontal and vertical rows on 30 mm centers, keep the ambient temperature below 40°C.

Operating Instructions

Applicable Wiring

(1) Contact Block 0.3 to 3.5 mm² (solid wire ø0.5 to 2.0 mm)Pushbutton/illuminated pushbutton/selector switch/
illuminated selector switch

Ⓐ and Ⓑ show the wiring direction to the terminals.

<Contact Block>

Terminal screws M3.5 (spring-up)

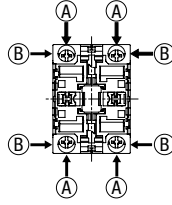

Applicable Crimping Terminal

Be sure to use an insulation tube or cover on the crimping part of the crimping terminal to prevent electrical shocks.

Crimping terminal for Ⓐ

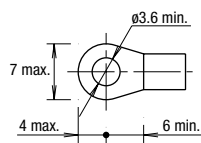
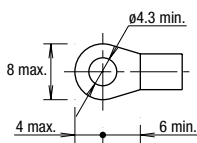

IP20 crimping terminal

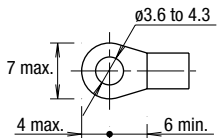

Crimping terminal for Ⓑ

IP20 crimping terminal

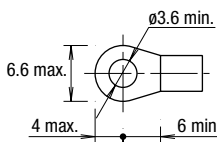

Solid wire

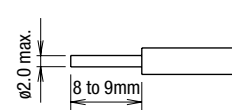

- Strip the wire insulation 8 to 9 mm from the end.
- Insert the wire until the insulation comes into contact with the terminal metal part.

(2) Power Unit 0.3 to 2 mm² (solid wire ø0.5 to 1.6 mm)

Illuminated pushbutton/illuminated selector switch

Ⓐ and Ⓑ show the wiring direction to the terminals.

<Full Voltage Adapter>

Terminal screws M3.5 (spring-up)

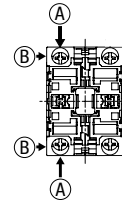

<Transformer Unit>

100/110V AC, 200/220V

Terminal screws M3.5 (spring-up)

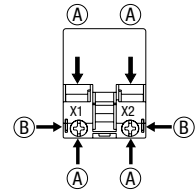

<DC-DC Converter Unit/Transformer Unit>

110V DC, 380V

Terminal screws M3.5 (spring-up)

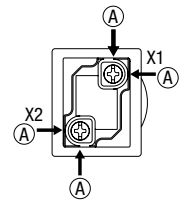

Applicable Crimping Terminal

Be sure to use an insulation tube or cover on the crimping part of the crimping terminal to prevent electrical shocks.

Crimping terminal for Ⓐ

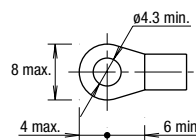

Crimping terminal for Ⓑ

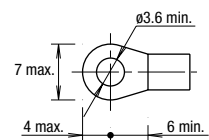

Solid wire

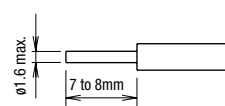

- Strip the wire insulation 7 to 8 mm from the end.
- Insert the wire until the insulation comes into contact with the terminal metal part.

- Terminal cover is integrated in the full voltage adapter and transformer unit. Note that the connection terminal is not IP20.

(1)-1 IP20 Degree of Protection

The terminal of HW-U contact block has IP20 degree of protection.

When IP20 is required for wiring, observe the followings.

Make sure to insert the crimping terminal or wire to the terminal straight and fully.

When using a crimping terminal

Use IP20 crimping terminals.

When using a solid wire

Strip the wire insulation 8 to 9 mm from the end and insert the wire to the terminal fully.

When using a stranded wire

Strip the wire insulation 8 to 9 mm from the end and insert the wire to the terminal fully. Make sure that the wires are not loosened.

HW

TW

YW

APEM

Switches & Pilot Lights

Control Boxes

Emergency Stop Switches

Enabling Switches

Safety Products

Explosion Proof

Terminal Blocks

Relays & Sockets

Circuit Protectors

Power Supplies

LED Illumination

Controllers

Operator Interfaces

Sensors

AUTO-ID

Flush Silhouette

ø16

ø22

ø30

Miniature

Pilot Lights

HW

TW

YW

Operating Instructions

(3) Pilot Light 0.3 to 2 mm² (solid wire ø0.5 to 1.6 mm)

Applicable crimping terminal

Be sure to use an insulation tube or cover on the crimping part of the crimping terminal to prevent electrical shocks.

<Full Voltage Type>

6V, 12V, 24V AC/DC

Terminal screws M3.5 (self-lifting)

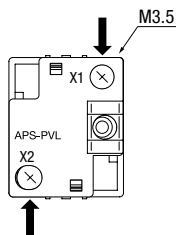
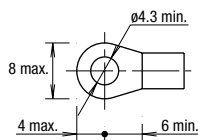

<Transformer Unit>

100/110V AC, 200/220V AC (240V AC maximum)

Terminal screws M3.5 (spring-up)

Crimping terminal for (A)

Crimping terminal for (B)

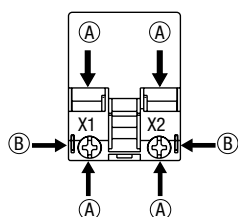
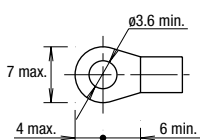
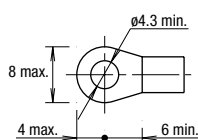

<DC-DC Converter Unit/Transformer Unit>

110V DC, 380V AC minimum

Terminal screws M3.5 (spring-up)

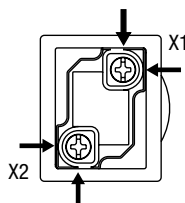
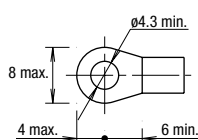

Solid wire

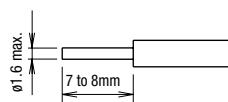

- Strip the wire insulation 7 to 8 mm from the end.
- Insert the wire until the insulation comes into contact with the terminal metal part.

- Install a terminal cover to 6, 12, 24V AC types. The connection terminal is not IP20.
- Terminal cover is integrated in the transformer and DC-DC converter unit. Note that the connection terminal is not IP20.
- When selecting mounting centers and crimping terminals, take sufficient insulation distance into consideration.

Cautions for Wiring

About using DC-DC Converter Unit

1. Note the polarity for wiring when connecting to the DC-DC converter.

Terminal No.	Polarity
X1	Positive
X2	Negative

2. Incandescent lamps cannot be used in DC-DC converter unit.

3. DC-DC converters are equipped with an electric circuit and noise may be heard inside the unit, which does not affect the performance of DC-DC converters.

Recommended Tightening Torque Number of Wires

Unit	Wire	Number of Wires	Recommended Tightening Torque	Terminal Screw	
HW-U Contact Block	Crimping Terminal	2	1.0 to 1.3	M3.5	
	Solid Wire	ø0.5 to 1.6 mm (AWG14 to 22)	2		1.0 to 1.3
		ø1.7 to 2.0 mm (AWG12)	1		1.2 to 1.3
	Stranded Wire	0.3 to 2.0 mm ² (AWG14 to 22)	2		1.0 to 1.3
2.1 to 3.5 mm ² (AWG12)		1	1.2 to 1.3		
Illuminated Unit (*1)	Crimping Terminal	2	1.0 to 1.3	M3.5	
	Solid Wire				ø0.5 to 1.6 mm (AWG14 to 22)
Pilot Light	Crimping Terminal	2	1.0 to 1.3	M3.5	
					Solid Wire
	Stranded Wire	0.3 to 2.0 mm ² (AWG14 to 22)			

*1) Lamp terminal of illuminated pushbuttons and illuminated selector switches

