

**MN 863**  
Plain door  
2 points lock

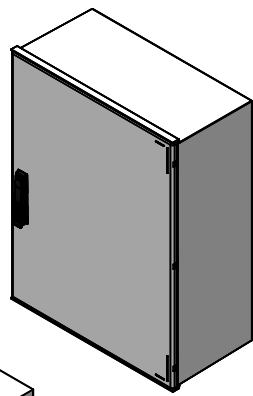

**MN 863/3P**  
Plain door  
3 points lock

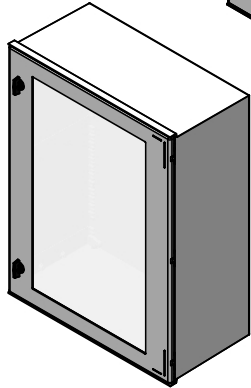

**MN 863-V**  
Door w/ window  
2 points lock

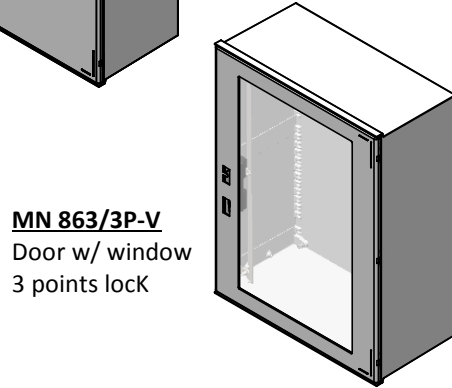

**MN 863/3P-V**  
Door w/ window  
3 points lock

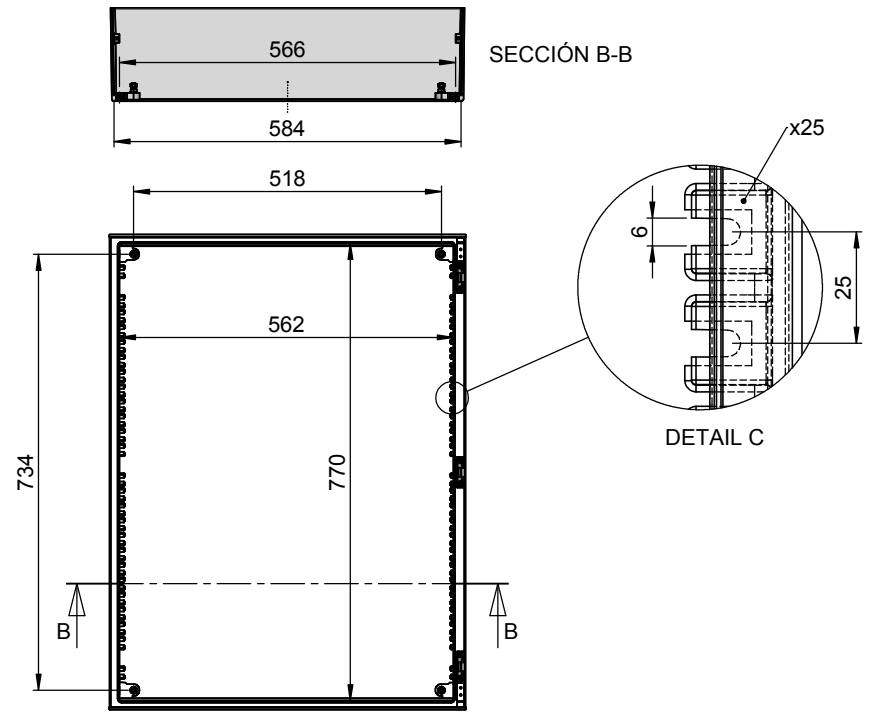
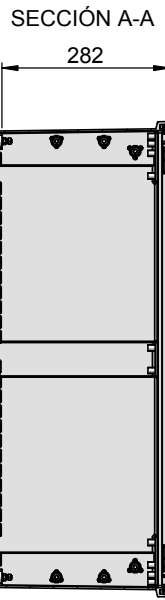
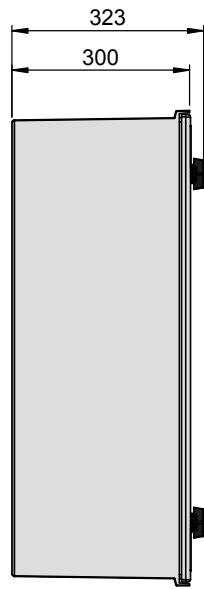
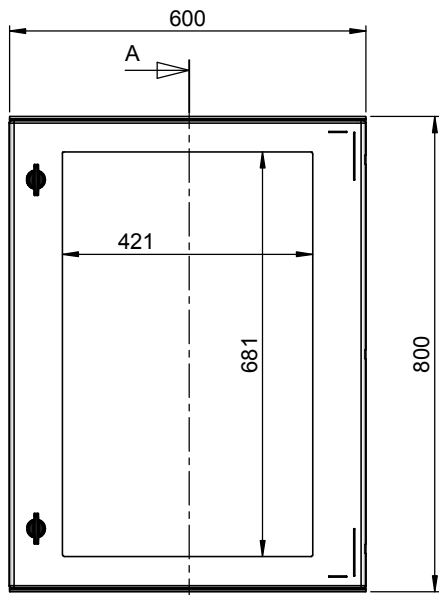

2 points locks Serrure 2 points Cerraduras 2 puntos					
		Double bit lock 3.0mm Double-barre DIN 3.0mm Doble barra DIN 3.0mm	Triangular screw 11mm Triangulaire 11mm Triangular 11mm	Manual with key lock à clé avec barillet Manual con llave	
Plain/Pleine/Plana	<b>MN 863</b>	06PF860001	06PF860021	06PF860031	
Window/Hublot/Ventana	<b>MN 863-V</b>	06PF860003	06PF860023	06PF860033	

3 points locks Serrure 3 points Cerraduras 3 puntos					
		Double bit lock Double barre DIN 3mm Cierre doble barra	Cylinder & key locked à clé avec barillet con bombín y llave	without cylinder & key sans barillet sin bombín	Triangular 11mm Triangulaire 11mm Triángulo de 11mm
Plain/Pleine/Plana	<b>MN 863/3P</b>	06PF860002	06PF860072	06PF860082	06PF860092
Window/Hublot/Ventana	<b>MN 863/3P -V</b>	06PF860004	06PF860074	06PF860084	06PF860094

- Envolvente de Poliéster (SMC), color RAL7035.
- Coffret de Polyester (SMC), couleur RAL7035.
- Polyester box (SMC), colour RAL7035.
- IP66 / IK10 / IK08 (w/ window / avec hublot / con ventana)

Certificado de Empresa AENOR 1990/0035/ER/01

DIBUJADO	HOJA Nº
JSO	1/1
FECHA:	25-05-2016

## MINIPOL 863 RANGE



FICHA Nº  
**FTM10283**