

ID	Description	Date	By	Appr.
A				

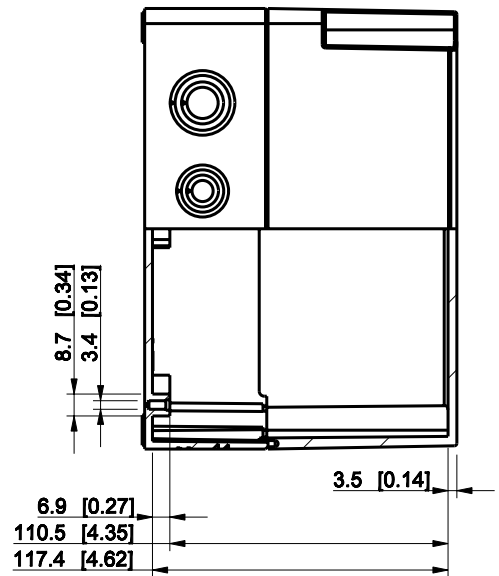
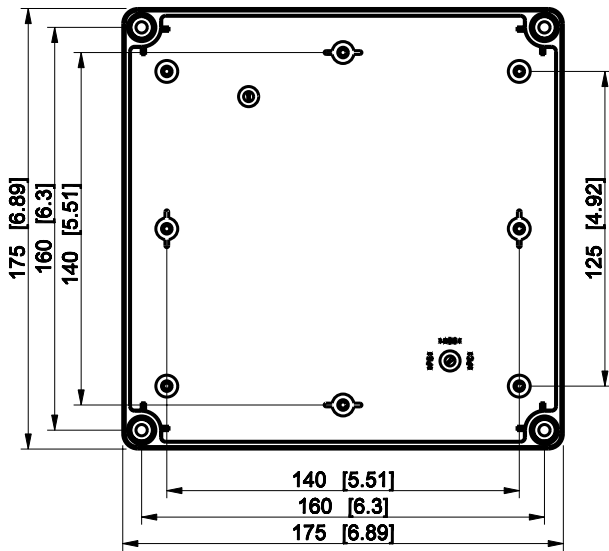
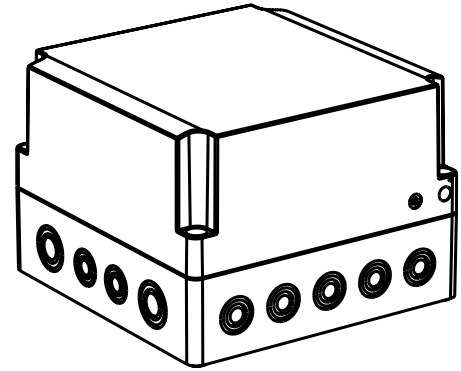
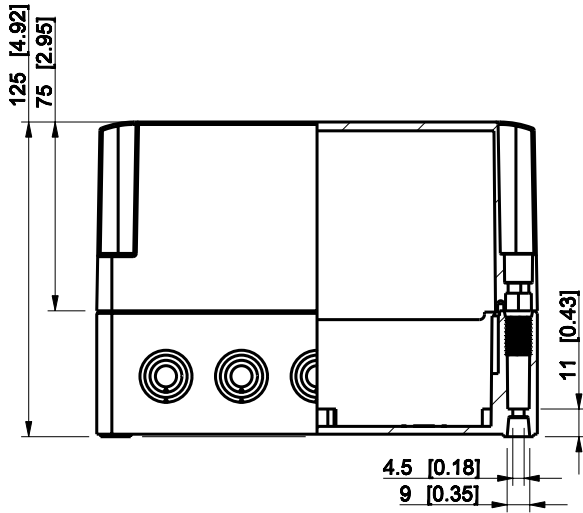

Dimensions in mm [inches]

Material: Polycarbonate, fiberglass-reinforced	Color: RAL 7035
--	-----------------

Supplier:	Tool No:	Weight [kg]: 0.58	Volume:
-----------	----------	-------------------	---------

ENSTO
ENSTO CONTROL OY

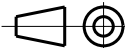

SPCM181813G

Scale	Date	08.12.08
1:3	By	PKos
-	Checked	
-	Ctrl	

Replaces:
Replaced:
Drw No: - A
Ref: Cubo S
Code: SPCM181813G
Sheet No:

model SPCM181813G PART
 drawing CUBOS DRAWING