

Tolerance ISO 2768-m	>0,5 =3 ±0,1	> =6 ±0,1	>6 =30 ±0,2	>30 =120 ±0,3	>120 =400 ±0,5	>400 =1000 ±0,8

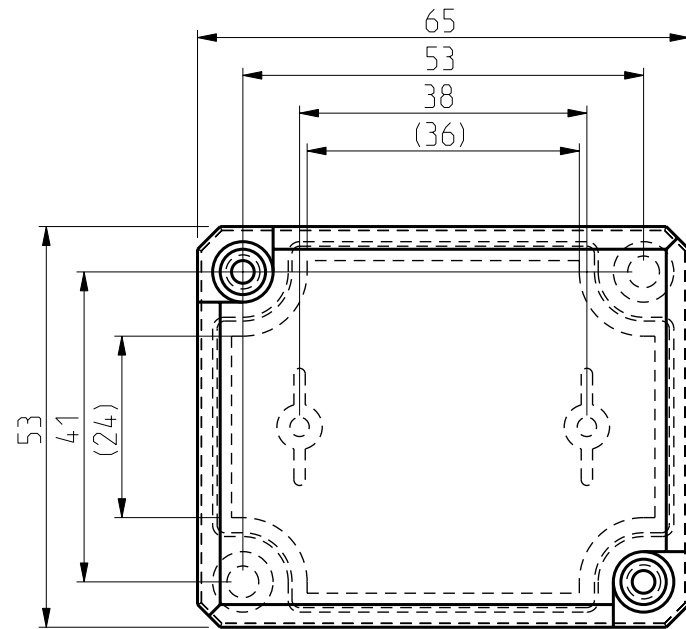

ENSTO
ENSTO CONTROL OY

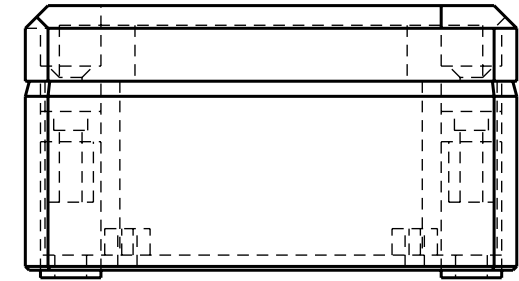
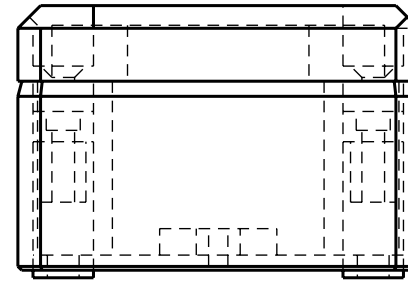
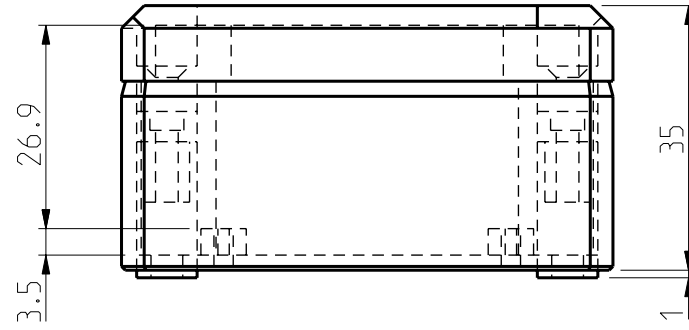
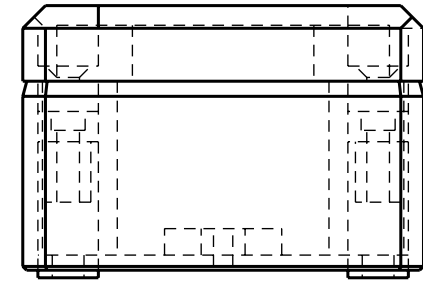
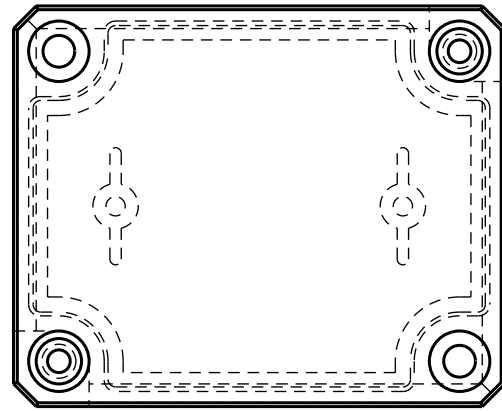
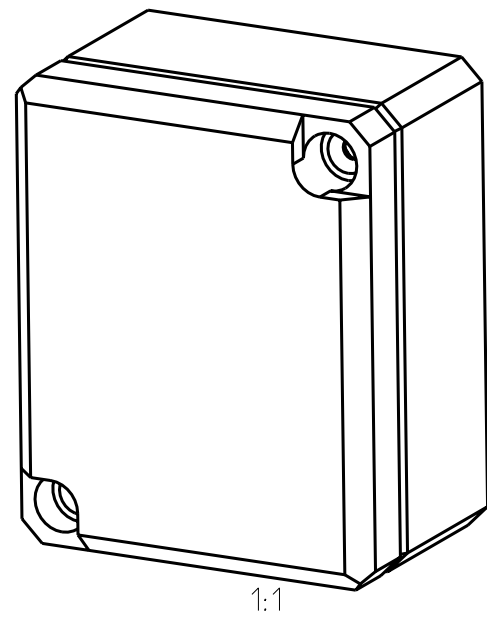
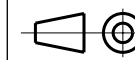

Scale	Date	21.10.04
1:1	By	MPL
-	Checked	
-	Ctrl	

CUBO D
DPCP 050704 G/T
DABP 050704 G/T

Replaces:	
Replaced:	
Drw No:	-
Ref:	-
Code:	-
Sheet No:	1 (1)