

1

2

3

4

5

6

7

8

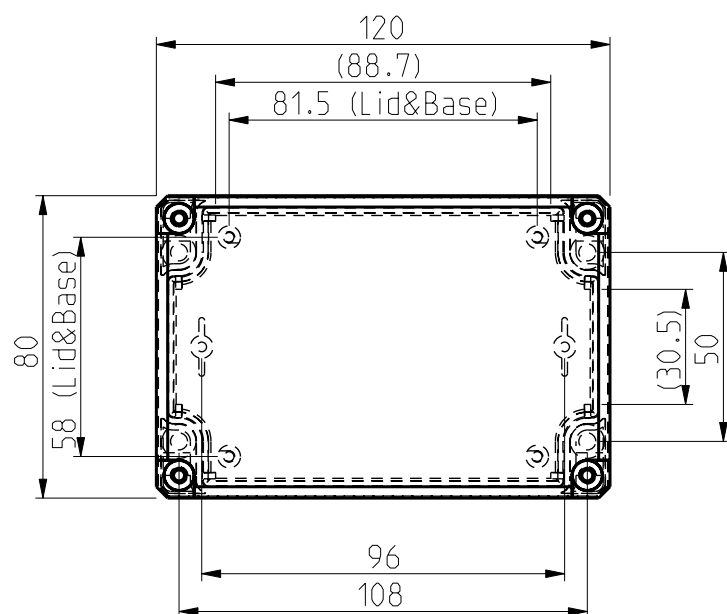
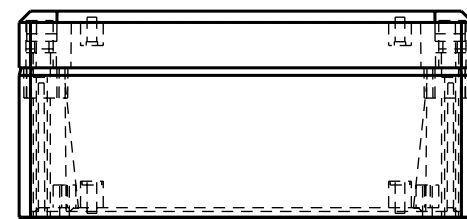
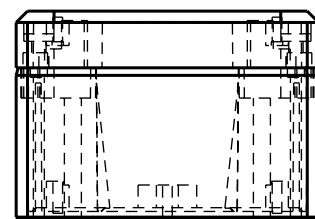
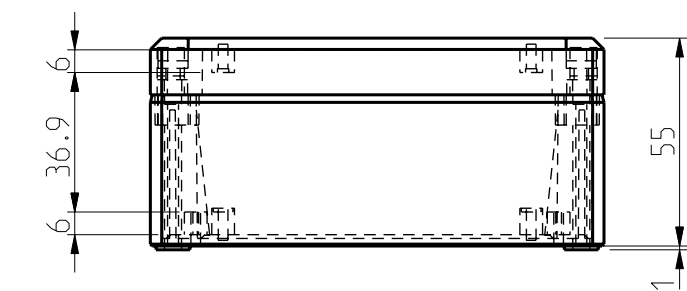
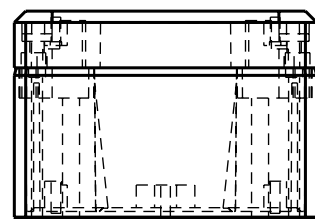
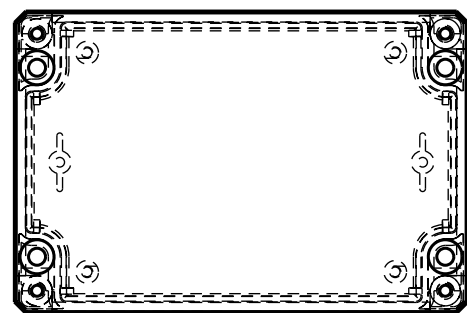
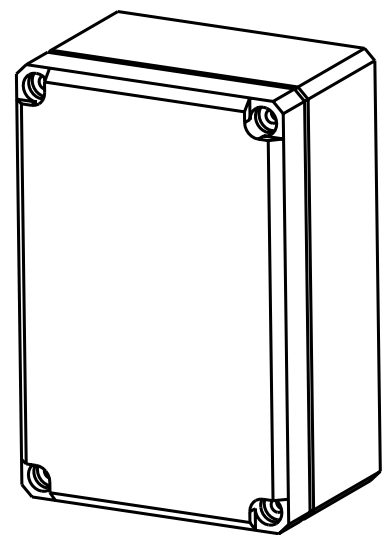

Tolerance ISO 2768-m	>0.5 =3 ±0.1	> =6 ±0.1	>6 =30 ±0.2	>120 =400 ±0.5	>400 =1000 ±0.8

ENSTO
ENSTO CONTROL OY

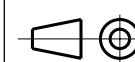

Scale	Date	21.10.04
1:2	By	MPL
-	Checked	
-	Ctrl	

CUBO D
DPCP 081206 G/T
DABP 081206 G/T

Replaces:	
Replaced:	
Drw No:	-
Ref:	-
Code:	-
Sheet No:	1 (1)

A

B

C

D

E