



- UL 1077 and UL 489 certified versions
- High breaking capacity
- Various trip characteristic curves: Type B, C or D
- Wide 1...125A current range
- Residuals with trip characteristic curves type A, AC and B
- Accessories available.

	<b>SEC. - PAGE</b>
<b>Miniature circuit breakers 1...63A, UL 1077</b>	
1P - 10kA, 1 module, curve types B, C and D .....	13 - 2
1P+N - 6kA, 1 module, curve type C .....	13 - 3
1P+N - 6kA, 2 modules, curve type C .....	13 - 3
2P - 10kA, 2 modules, curve types B, C and D .....	13 - 4
3P - 10kA, 3 modules, curve types B, C and D .....	13 - 5
4P - 10kA, 4 modules, curve types B, C and D .....	13 - 6
<b>Miniature circuit breakers 1...63A, UL 489</b>	
1P - 10kA, 1 module .....	13 - 7
2P - 10kA, 2 modules .....	13 - 8
3P - 10kA, 3 modules .....	13 - 9
<b>Miniature circuit breakers 80...125A, UL 1077</b>	
1P, 2P, 3P and 4P - 10kA, curve type C .....	13 - 10
3P and 4P - 10kA, curve type D .....	13 - 10
<b>Add-on blocks and accessories</b> .....	13 - 11
<b>Residual blocks</b> .....	13 - 13
<b>Residual current operated circuit breakers</b> .....	13 - 14
<b>Residual current operated circuit breakers with overcurrent protection</b> .....	13 - 15
<b>Dimensions</b> .....	<b>13 - 16</b>
<b>Wiring diagrams</b> .....	<b>13 - 16</b>
<b>Technical characteristics</b> .....	<b>13 - 17</b>



Page 13-2

### MINIATURE CIRCUIT BREAKERS UP TO 63A

- 1P, 1P+N, 2P, 3P and 4P versions
- IEC rated current  $I_n$ : 1...63A
- IEC short-circuit breaking capacity  $I_{cn}$ : 10kA (6kA for 1P+N)
- Trip characteristic curve: Type B, C, D
- UL 1077 or UL 489 certified versions.



Page 13-10

### MINIATURE CIRCUIT BREAKERS 80...125A

- 1P, 2P, 3P and 4P versions
- IEC rated current  $I_n$ : 80...125A
- IEC short-circuit breaking capacity  $I_{cn}$ : 10kA
- Trip characteristic curve: Type C, D
- UL 1077 certified versions.



Page 13-11

### ADD-ON BLOCKS AND ACCESSORIES

- Auxiliary and indicator contacts
- Undervoltage trip releases
- Shunt trip releases
- Connection accessories
- UL 1077 or UL 489 certified versions
- Modular 16A socket.



Page 13-13

### RESIDUAL BLOCKS FOR CIRCUIT BREAKERS UP TO 63A

- 2P, 3P and 4P versions
- IEC rated current  $I_n$ : 40 and 63A
- Residual current: 30 and 300mA
- Residual current operating characteristic: Type A.



Page 13-14

### RESIDUAL CURRENT OPERATED CIRCUIT BREAKERS 25...63A

- 2P and 4P versions
- IEC rated current  $I_n$ : 25, 40 and 63A
- IEC rated residual operating current  $I_{\Delta n}$ : 30mA and 300mA
- Residual current operating characteristic: Type A, B and AC.



Page 13-15

### RESIDUAL CURRENT OPERATED CIRCUIT BREAKERS WITH OVERCURRENT PROTECTION UP TO 40A

- 1P+N versions
- IEC rated current  $I_n$ : 6...40A
- IEC rated short-circuit capacity  $I_{cn}$ : 10kA
- Trip characteristic curve: Type C
- Residual current: 30 and 300mA
- Residual current operating characteristic: Type AC and A.

### 1P - 10kA 1 module



P1 MB 1P...



Order code	Curve	IEC In	IEC Icn	N° of DIN module	Qty per pkg	Wt
		[A]	[kA]	n°	n°	[kg]

Single pole, thermal and magnetic trip type, B-curve characteristic.

P1 MB 1P B01	B	1	10	1	12	0.115
P1 MB 1P B02	B	2	10	1	12	0.115
P1 MB 1P B04	B	4	10	1	12	0.115
P1 MB 1P B06	B	6	10	1	12	0.115
P1 MB 1P B10	B	10	10	1	12	0.115
P1 MB 1P B13	B	13	10	1	12	0.115
P1 MB 1P B16	B	16	10	1	12	0.115
P1 MB 1P B20	B	20	10	1	12	0.115
P1 MB 1P B25	B	25	10	1	12	0.115
P1 MB 1P B32	B	32	10	1	12	0.115
P1 MB 1P B40	B	40	10	1	12	0.115
P1 MB 1P B50	B	50	10	1	12	0.115
P1 MB 1P B63	B	63	10	1	12	0.115

Single pole, thermal and magnetic trip type, C-curve characteristic.

P1 MB 1P C01	C	1	10	1	12	0.115
P1 MB 1P C02	C	2	10	1	12	0.115
P1 MB 1P C04	C	4	10	1	12	0.115
P1 MB 1P C06	C	6	10	1	12	0.115
P1 MB 1P C10	C	10	10	1	12	0.115
P1 MB 1P C13	C	13	10	1	12	0.115
P1 MB 1P C16	C	16	10	1	12	0.115
P1 MB 1P C20	C	20	10	1	12	0.115
P1 MB 1P C25	C	25	10	1	12	0.115
P1 MB 1P C32	C	32	10	1	12	0.115
P1 MB 1P C40	C	40	10	1	12	0.115
P1 MB 1P C50	C	50	10	1	12	0.115
P1 MB 1P C63	C	63	10	1	12	0.115

Single pole, thermal and magnetic trip type, D-curve characteristic.

P1 MB 1P D01	D	1	10	1	12	0.115
P1 MB 1P D02	D	2	10	1	12	0.115
P1 MB 1P D04	D	4	10	1	12	0.115
P1 MB 1P D06	D	6	10	1	12	0.115
P1 MB 1P D10	D	10	10	1	12	0.115
P1 MB 1P D13	D	13	10	1	12	0.115
P1 MB 1P D16	D	16	10	1	12	0.115
P1 MB 1P D20	D	20	10	1	12	0.115
P1 MB 1P D25	D	25	10	1	12	0.115
P1 MB 1P D32	D	32	10	1	12	0.115
P1 MB 1P D40	D	40	10	1	12	0.115
P1 MB 1P D50	D	50	10	1	12	0.115
P1 MB 1P D63	D	63	10	1	12	0.115

### General characteristics

These devices are used to protect against short circuits and overloads of wiring installations and loads in panel boards, office buildings, stores and similar applications.

Their purpose is circuit protection, circuit isolation and load operation controls. They have instantaneous trip characteristics defined as follows:

- B-curve: instantaneous trip 3...5 times  $I_n$  for non-inductive or low inductive loads (heating resistors, generators, very long wire lines)
- C-curve: instantaneous trip 5...10 times  $I_n$  for inductive loads (mixed and inductive resistive loads with low inrush current)
- D-curve: instantaneous trip 10...14 times  $I_n$  for highly inductive loads (loads with high inrush and current such as motors).

Main features include:

- IEC rated current  $I_n$ : 1...63A
- Pole width: 17.5mm / 0.69"
- Contact status with flag indicator
- Trip characteristic: Curve type B, C and D
- Auxiliary contacts and trip releases mounted on MCB left side
- Fixing on 35mm DIN rail (IEC/EN 60715).

### Operational characteristics

- Dissipation per pole: 3...13W
- IEC rated insulation voltage  $U_i$ : 440V
- IEC rated impulse voltage  $U_{imp}$ : 4kV
- IEC rated operational voltage  $U_e$ : 230/400VAC.

### UL rating

Rated voltage: 240VAC - 7.5kA  
Rated voltage: 277VAC - 5kA.

### Certifications and compliance

Certifications obtained: EAC; TÜV – Rheinland; UL  
Recognized for USA and Canada (cURus – File E359585) as "Supplementary Protectors", designated as Overcurrent type, for general industrial use, suitable for factory wiring only with 125-135% tripping current of amp rating.  
Products having this type of marking are intended for use as components of complete workshop- assembled equipment.  
Compliant with standards: IEC/EN 60898-1, IEC/EN 60947-2, UL 1077, CSA C22.2 n°235.

### 1P+N - 6kA 1 module



P1 MB 1M...

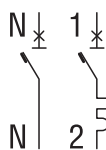

Order code	Curve	IEC In	IEC Icn	N° of DIN module	Qty per pkg	Wt
		[A]	[kA]	n°	n°	[kg]

Single pole + neutral, thermal and magnetic trip type, B-curve characteristic.

P1 MB 1M B06	B	6	6	1	12	0.115
P1 MB 1M B10	B	10	6	1	12	0.115
P1 MB 1M B16	B	16	6	1	12	0.115
P1 MB 1M B20	B	20	6	1	12	0.115
P1 MB 1M B25	B	25	6	1	12	0.115
P1 MB 1M B32	B	32	6	1	12	0.115

Single pole + neutral, thermal and magnetic trip type, C-curve characteristic.

P1 MB 1M C02	C	2	6	1	12	0.115
P1 MB 1M C04	C	4	6	1	12	0.115
P1 MB 1M C06	C	6	6	1	12	0.115
P1 MB 1M C10	C	10	6	1	12	0.115
P1 MB 1M C13	C	13	6	1	12	0.115
P1 MB 1M C16	C	16	6	1	12	0.115
P1 MB 1M C20	C	20	6	1	12	0.115
P1 MB 1M C25	C	25	6	1	12	0.115
P1 MB 1M C32	C	32	6	1	12	0.115
P1 MB 1M C40	C	40	6	1	12	0.115

#### General characteristics

These devices are used to protect against short circuits and overloads of wiring installations and loads in panel boards, office buildings, stores and similar applications.

Their purpose is circuit protection, circuit isolation and load operation controls. They have characteristics of instantaneous trip defined as follows:

- B-curve: instantaneous trip 3...5 times In for non-inductive or low inductive loads (heating resistors, generators, very long wire lines)
- C-curve: instantaneous trip 5...10 times In for inductive loads (mixed loads, resistive and inductive with low inrush current)
- D-curve: instantaneous trip 10...14 times In for highly inductive loads (loads with high inrush and current such as motors).

Main features include:

- IEC rated current In: 2...40A
- Pole width: 9mm/0.35" (0.5 module)
- Contact status with flag indicator
- Trip characteristic: Curve type B and C
- Auxiliary contacts and trip releases mounted on left side
- Fixing on 35mm DIN rail (IEC/EN 60715).

#### Operational characteristics

- Dissipation per pole: 3...7.5W
- IEC rated insulation voltage Ui: 440V
- IEC rated impulse voltage Uimp: 4kV
- IE rated operational voltage Ue: 230VAC.

#### Certifications and compliance

Certifications obtained: EAC, TÜV Rheinland.  
Compliant with standards: IEC/EN 60898-1, IEC/EN 60947-2.

### 1P+N - 6kA 2 modules



P1 MB 1N...

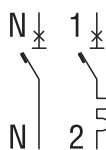

Order code	Curve	IEC In	IEC Icn	N° of DIN module	Qty per pkg	Wt
		[A]	[kA]	no.	n°	[kg]

Single pole + neutral, thermal and magnetic trip type, C-curve characteristic.

P1 MB 1N C01	C	1	6	2	6	0.190
P1 MB 1N C02	C	2	6	2	6	0.190
P1 MB 1N C04	C	4	6	2	6	0.190
P1 MB 1N C06	C	6	6	2	6	0.190
P1 MB 1N C10	C	10	6	2	6	0.190
P1 MB 1N C16	C	16	6	2	6	0.190
P1 MB 1N C20	C	20	6	2	6	0.190
P1 MB 1N C25	C	25	6	2	6	0.190
P1 MB 1N C32	C	32	6	2	6	0.190
P1 MB 1N C40	C	40	6	2	6	0.190
P1 MB 1N C50	C	50	6	2	6	0.190
P1 MB 1N C63	C	63	6	2	6	0.190

#### General characteristics

- IEC rated current In: 1...63A
- Pole width: 17.5mm / 0.69"
- Contact status with flag indicator
- Trip characteristic: Curve type C
- Auxiliary contacts and trip releases mounted on left side
- Fixing on 35mm DIN rail (IEC/EN 60715).

#### Operational characteristics

- Dissipation per pole: 3...13W
- IEC rated insulation voltage Ui: 440V
- IEC rated impulse voltage Uimp: 4kV
- IEC rated operational voltage Ue: 230/400VAC.

#### Certifications and compliance

Certifications obtained: EAC.  
Compliant with standards: IEC/EN 60898-1, IEC/EN 60947-2.

### 2P - 10kA 2 modules



P1 MB 2P...

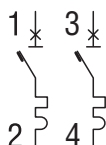

Order code	Curve	IEC In	IEC Icn	N° of DIN module	Qty per pkg	Wt
		[A]	[kA]	n°	n°	[kg]

Two pole, thermal and magnetic trip type, B-curve characteristic.

P1 MB 2P B01	B	1	10	2	6	0.230
P1 MB 2P B02	B	2	10	2	6	0.230
P1 MB 2P B04	B	4	10	2	6	0.230
P1 MB 2P B06	B	6	10	2	6	0.230
P1 MB 2P B10	B	10	10	2	6	0.230
P1 MB 2P B13	B	13	10	2	6	0.230
P1 MB 2P B16	B	16	10	2	6	0.230
P1 MB 2P B20	B	20	10	2	6	0.230
P1 MB 2P B25	B	25	10	2	6	0.230
P1 MB 2P B32	B	32	10	2	6	0.230
P1 MB 2P B40	B	40	10	2	6	0.230
P1 MB 2P B50	B	50	10	2	6	0.230
P1 MB 2P B63	B	63	10	2	6	0.230

Two pole, thermal and magnetic trip type, C-curve characteristic.

P1 MB 2P C01	C	1	10	2	6	0.230
P1 MB 2P C02	C	2	10	2	6	0.230
P1 MB 2P C04	C	4	10	2	6	0.230
P1 MB 2P C06	C	6	10	2	6	0.230
P1 MB 2P C10	C	10	10	2	6	0.230
P1 MB 2P C13	C	13	10	2	6	0.230
P1 MB 2P C16	C	16	10	2	6	0.230
P1 MB 2P C20	C	20	10	2	6	0.230
P1 MB 2P C25	C	25	10	2	6	0.230
P1 MB 2P C32	C	32	10	2	6	0.230
P1 MB 2P C40	C	40	10	2	6	0.230
P1 MB 2P C50	C	50	10	2	6	0.230
P1 MB 2P C63	C	63	10	2	6	0.230

Two pole, thermal and magnetic trip type, D-curve characteristic.

P1 MB 2P D01	D	1	10	2	6	0.230
P1 MB 2P D02	D	2	10	2	6	0.230
P1 MB 2P D04	D	4	10	2	6	0.230
P1 MB 2P D06	D	6	10	2	6	0.230
P1 MB 2P D10	D	10	10	2	6	0.230
P1 MB 2P D13	D	13	10	2	6	0.230
P1 MB 2P D16	D	16	10	2	6	0.230
P1 MB 2P D20	D	20	10	2	6	0.230
P1 MB 2P D25	D	25	10	2	6	0.230
P1 MB 2P D32	D	32	10	2	6	0.230
P1 MB 2P D40	D	40	10	2	6	0.230
P1 MB 2P D50	D	50	10	2	6	0.230
P1 MB 2P D63	D	63	10	2	6	0.230

### General characteristics

These devices are used to protect against short circuits and overloads of wiring installations and loads in panel boards, office buildings, stores and similar applications.

Their purpose is circuit protection, circuit isolation and load operation controls. They have characteristics of instantaneous trip defined as follows:

- B-curve: instantaneous trip 3...5 times I<sub>n</sub> for non-inductive or low inductive loads (heating resistors, generators, very long wire lines)
- C-curve: instantaneous trip 5...10 times I<sub>n</sub> for inductive loads (mixed loads, resistive and inductive with low inrush current)
- D-curve: instantaneous trip 10...14 times I<sub>n</sub> for highly inductive loads (loads with high inrush and current such as motors).

Main features include:

- IEC rated current I<sub>n</sub>: 1...63A
- Pole width: 17.5mm / 0.69"
- Contact status with flag indicator
- Trip characteristic: Curve type B, C and D
- Auxiliary contacts and trip releases mounted on left side
- Fixing on 35mm DIN rail (IEC/EN 60715).

### Operational characteristics

- Dissipation per pole: 3...13W
- IEC rated insulation voltage U<sub>i</sub>: 440V
- IEC rated impulse voltage U<sub>imp</sub>: 4kV
- IEC rated operational voltage U<sub>e</sub>: 230/400VAC.

### UL rating

Rated voltage: 480VAC - 7.5kA

### Certifications and compliance

Certifications obtained: EAC, TÜV – Rheinland; UL Recognized for USA and Canada (cURus – File E359585) as "Supplementary Protectors", designated as Overcurrent type, for general industrial use, suitable for factory wiring only with 125-135% tripping current of amp rating. Products having this type of marking are intended for use as components of complete workshop- assembled equipment. Compliant with standards: IEC/EN 60898-1, IEC/EN 60947-2, UL 1077, CSA C22.2 n°235.

### 3P - 10kA 3 modules



P1 MB 3P...

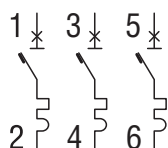

Order code	Curve	IEC In	IEC Icn	N° of DIN module	Qty per pkg	Wt
		[A]	[kA]	n°	n°	[kg]

Three pole, thermal and magnetic trip type, B-curve characteristic.

P1 MB 3P B01	B	1	10	3	4	0.345
P1 MB 3P B02	B	2	10	3	4	0.345
P1 MB 3P B04	B	4	10	3	4	0.345
P1 MB 3P B06	B	6	10	3	4	0.345
P1 MB 3P B10	B	10	10	3	4	0.345
P1 MB 3P B13	B	13	10	3	4	0.345
P1 MB 3P B16	B	16	10	3	4	0.345
P1 MB 3P B20	B	20	10	3	4	0.345
P1 MB 3P B25	B	25	10	3	4	0.345
P1 MB 3P B32	B	32	10	3	4	0.345
P1 MB 3P B40	B	40	10	3	4	0.345
P1 MB 3P B50	B	50	10	3	4	0.345
P1 MB 3P B63	B	63	10	3	4	0.345

Three pole, thermal and magnetic trip type, C-curve characteristic.

P1 MB 3P C01	C	1	10	3	4	0.345
P1 MB 3P C02	C	2	10	3	4	0.345
P1 MB 3P C04	C	4	10	3	4	0.345
P1 MB 3P C06	C	6	10	3	4	0.345
P1 MB 3P C10	C	10	10	3	4	0.345
P1 MB 3P C13	C	13	10	3	4	0.345
P1 MB 3P C16	C	16	10	3	4	0.345
P1 MB 3P C20	C	20	10	3	4	0.345
P1 MB 3P C25	C	25	10	3	4	0.345
P1 MB 3P C32	C	32	10	3	4	0.345
P1 MB 3P C40	C	40	10	3	4	0.345
P1 MB 3P C50	C	50	10	3	4	0.345
P1 MB 3P C63	C	63	10	3	4	0.345

Three pole, thermal and magnetic trip type, D-curve characteristic.

P1 MB 3P D01	D	1	10	3	4	0.345
P1 MB 3P D02	D	2	10	3	4	0.345
P1 MB 3P D04	D	4	10	3	4	0.345
P1 MB 3P D06	D	6	10	3	4	0.345
P1 MB 3P D10	D	10	10	3	4	0.345
P1 MB 3P D13	D	13	10	3	4	0.345
P1 MB 3P D16	D	16	10	3	4	0.345
P1 MB 3P D20	D	20	10	3	4	0.345
P1 MB 3P D25	D	25	10	3	4	0.345
P1 MB 3P D32	D	32	10	3	4	0.345
P1 MB 3P D40	D	40	10	3	4	0.345
P1 MB 3P D50	D	50	10	3	4	0.345
P1 MB 3P D63	D	63	10	3	4	0.345

#### General characteristics

These devices are used to protect against short circuits and overloads of wiring installations and loads in panel boards, office buildings, stores and similar applications.

Their purpose is circuit protection, circuit isolation and load operation controls. They have characteristics of instantaneous trip defined as follows:

- B-curve: instantaneous trip 3...5 times  $I_n$  for non-inductive or low inductive loads (heating resistors, generators, very long wire lines)
- C-curve: instantaneous trip 5...10 times  $I_n$  for inductive loads (mixed loads, resistive and inductive with low inrush current)
- D-curve: instantaneous trip 10...14 times  $I_n$  for highly inductive loads (loads with high inrush and current such as motors).

Main features include:

- IEC rated current  $I_n$ : 1...63A
- Pole width: 17.5mm / 0.69"
- Contact status with flag indicator
- Trip characteristic: Curve type B, C and D
- Auxiliary contacts and trip releases mounted on left side
- Fixing on 35mm DIN rail (IEC/EN 60715).

#### Operational characteristics

- Dissipation per pole: 3...13W
- IEC rated insulation voltage  $U_i$ : 440V
- IEC rated impulse voltage  $U_{imp}$ : 4kV
- IEC rated operational voltage  $U_e$ : 230/400VAC.

#### UL rating

Rated voltage: 480VAC - 7.5kA

#### Certifications and compliance

Certifications obtained: EAC, TÜV – Rheinland; UL. Recognized for USA and Canada (cURus – File E359585) as "Supplementary Protectors", designated as Overcurrent type, for general industrial use, suitable for factory wiring only with 125-135% tripping current of amp rating. Products having this type of marking are intended for use as components of complete workshop- assembled equipment. Compliant with standards: IEC/EN 60898-1, IEC/EN 60947-2, UL 1077, CSA C22.2 n°235.



### 4P - 10kA 4 modules



P1 MB 4P...

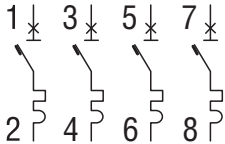

Order code	Curve	IEC In	IEC Icn	N° of DIN module	Qty per pkg	Wt
		[A]	[kA]	n°	n°	[kg]

Four pole, thermal and magnetic trip type, B-curve characteristic.

P1 MB 4P B01	B	1	10	4	3	0.460
P1 MB 4P B02	B	2	10	4	3	0.460
P1 MB 4P B04	B	4	10	4	3	0.460
P1 MB 4P B06	B	6	10	4	3	0.460
P1 MB 4P B10	B	10	10	4	3	0.460
P1 MB 4P B13	B	13	10	4	3	0.460
P1 MB 4P B16	B	16	10	4	3	0.460
P1 MB 4P B20	B	20	10	4	3	0.460
P1 MB 4P B25	B	25	10	4	3	0.460
P1 MB 4P B32	B	32	10	4	3	0.460
P1 MB 4P B40	B	40	10	4	3	0.460
P1 MB 4P B50	B	50	10	4	3	0.460
P1 MB 4P B63	B	63	10	4	3	0.460

Four pole, thermal and magnetic trip type, C-curve characteristic.

P1 MB 4P C01	C	1	10	4	3	0.460
P1 MB 4P C02	C	2	10	4	3	0.460
P1 MB 4P C04	C	4	10	4	3	0.460
P1 MB 4P C06	C	6	10	4	3	0.460
P1 MB 4P C10	C	10	10	4	3	0.460
P1 MB 4P C13	C	13	10	4	3	0.460
P1 MB 4P C16	C	16	10	4	3	0.460
P1 MB 4P C20	C	20	10	4	3	0.460
P1 MB 4P C25	C	25	10	4	3	0.460
P1 MB 4P C32	C	32	10	4	3	0.460
P1 MB 4P C40	C	40	10	4	3	0.460
P1 MB 4P C50	C	50	10	4	3	0.460
P1 MB 4P C63	C	63	10	4	3	0.460

Four pole, thermal and magnetic trip type, D-curve characteristic.

P1 MB 4P D01	D	1	10	4	3	0.460
P1 MB 4P D02	D	2	10	4	3	0.460
P1 MB 4P D04	D	4	10	4	3	0.460
P1 MB 4P D06	D	6	10	4	3	0.460
P1 MB 4P D10	D	10	10	4	3	0.460
P1 MB 4P D13	D	13	10	4	3	0.460
P1 MB 4P D16	D	16	10	4	3	0.460
P1 MB 4P D20	D	20	10	4	3	0.460
P1 MB 4P D25	D	25	10	4	3	0.460
P1 MB 4P D32	D	32	10	4	3	0.460
P1 MB 4P D40	D	40	10	4	3	0.460
P1 MB 4P D50	D	50	10	4	3	0.460
P1 MB 4P D63	D	63	10	4	3	0.460

### General characteristics

These devices are used to protect against short circuits and overloads of wiring installations and loads in panel boards, office buildings, stores and similar applications.

Their purpose is circuit protection, circuit isolation and load operation controls. They have characteristics of instantaneous trip defined as follows:

- B-curve: instantaneous trip 3...5 times  $I_n$  for non-inductive or low inductive loads (heating resistors, generators, very long wire lines)
- C-curve: instantaneous trip 5...10 times  $I_n$  for inductive loads (mixed loads, resistive and inductive with low inrush current)
- D-curve: instantaneous trip 10...14 times  $I_n$  for highly inductive loads (loads with high inrush and current such as motors).

Main features include:

- IEC rated current  $I_n$ : 1...63A
- Pole width: 17.5mm / 0.69"
- Contact status with flag indicator
- Trip characteristic: Curve type B, C and D
- Auxiliary contacts and trip releases mounted on left side
- Fixing on 35mm DIN rail (IEC/EN 60715).

### Operational characteristics

- Dissipation per pole: 3...13W
- IEC rated insulation voltage  $U_i$ : 440V
- IEC rated impulse voltage  $U_{imp}$ : 4kV
- IEC rated operational voltage  $U_e$ : 230/400VAC.

### UL rating

Rated voltage: 480VAC - 7.5kA

### Certifications and compliance

Certifications obtained: EAC, TÜV – Rheinland; UL Recognized for USA and Canada (cURus – File E359585) as "Supplementary Protectors", designated as Overcurrent type, for general industrial use, suitable for factory wiring only with 125-135% tripping current of amp rating. Products having this type of marking are intended for use as components of complete workshop- assembled equipment. Compliant with standards: IEC/EN 60898-1, IEC/EN 60947-2, UL 1077, CSA C22.2 n°235.

### 1P - 10kA 1 module



P1 MB... 1P...



Order code	Curve	IEC In	Rat. volt.	N° of DIN mod.	Qty per pkg	Wt
		[A]	[V]	n°	n°	[kg]

One pole, thermal and magnetic trip type, C-curve characteristic.

P1 MB UH 1P C01	C	1	277	1	12	0.133
P1 MB UH 1P C01V6	C	1.6	277	1	12	0.133
P1 MB UH 1P C02	C	2	277	1	12	0.133
P1 MB UH 1P C03	C	3	277	1	12	0.133
P1 MB UH 1P C04	C	4	277	1	12	0.133
P1 MB UH 1P C05	C	5	277	1	12	0.133
P1 MB UH 1P C06	C	6	277	1	12	0.133
P1 MB UH 1P C07	C	7	277	1	12	0.133
P1 MB UH 1P C08	C	8	277	1	12	0.133
P1 MB UH 1P C10	C	10	277	1	12	0.133
P1 MB UH 1P C12	C	12	277	1	12	0.133
P1 MB UH 1P C13	C	13	277	1	12	0.133
P1 MB UH 1P C15	C	15	277	1	12	0.133
P1 MB UH 1P C16	C	16	277	1	12	0.133
P1 MB UH 1P C20	C	20	277	1	12	0.133
P1 MB UH 1P C25	C	25	277	1	12	0.133
P1 MB UH 1P C30	C	30	277	1	12	0.133
P1 MB UH 1P C32	C	32	277	1	12	0.133
P1 MB UL 1P C35	C	35	120	1	12	0.133
P1 MB UL 1P C40	C	40	120	1	12	0.133
P1 MB UL 1P C50	C	50	120	1	12	0.133
P1 MB UL 1P C60	C	60	120	1	12	0.133
P1 MB UL 1P C63	C	63	120	1	12	0.133

One pole, thermal and magnetic trip type, D-curve characteristic.

P1 MB UH 1P D01	D	1	277	1	12	0.133
P1 MB UH 1P D01V6	D	1.6	277	1	12	0.133
P1 MB UH 1P D02	D	2	277	1	12	0.133
P1 MB UH 1P D03	D	3	277	1	12	0.133
P1 MB UH 1P D04	D	4	277	1	12	0.133
P1 MB UH 1P D05	D	5	277	1	12	0.133
P1 MB UH 1P D06	D	6	277	1	12	0.133
P1 MB UH 1P D07	D	7	277	1	12	0.133
P1 MB UH 1P D08	D	8	277	1	12	0.133
P1 MB UH 1P D10	D	10	277	1	12	0.133
P1 MB UH 1P D12	D	12	277	1	12	0.133
P1 MB UH 1P D13	D	13	277	1	12	0.133
P1 MB UH 1P D15	D	15	277	1	12	0.133
P1 MB UH 1P D16	D	16	277	1	12	0.133
P1 MB UH 1P D20	D	20	277	1	12	0.133
P1 MB UH 1P D25	D	25	277	1	12	0.133
P1 MB UH 1P D30	D	30	277	1	12	0.133
P1 MB UH 1P D32	D	32	277	1	12	0.133
P1 MB UL 1P D35	D	35	120	1	12	0.133
P1 MB UL 1P D40	D	40	120	1	12	0.133
P1 MB UL 1P D50	D	50	120	1	12	0.133
P1 MB UL 1P D60	D	60	120	1	12	0.133
P1 MB UL 1P D63	D	63	120	1	12	0.133

#### General characteristics

These devices comply with the UL 489 standard, mostly used in the North American markets, are designed to protect feeder circuits, the part of the system from the network supply point to the protection device for a branch circuit. They can in any case be used on the international market thanks to compliance with the IEC/EN60947-2 standard as well.

They have characteristics of tripping instantaneously defined as follows:

- C-curve: instantaneous trip 5...10 times In for inductive loads (mixed loads, resistive and inductive with low inrush current)
- D-curve: instantaneous trip 10...14 times In for highly inductive loads (loads with high inrush and current such as motors).

#### Operational characteristics

- Dissipation per pole: 3...13W
- Rated voltage 1...32A: 277V (UL489)
- Rated voltage 35...63A: 120V (UL489)
- Rated insulation voltage Ui: 440V (IEC/EN60947-2)
- Rated impulse voltage Uimp: 4kV (IEC/EN60947-2)
- Rated operational voltage Ue: 230/400VAC (IEC/EN60947-2)
- DC operational voltage: 60V

#### Certifications and compliance

Certifications obtained: EAC, cULus (E471594).  
Compliant with standards: UL 489, IEC/EN 60947-2.



### 2P - 10kA 2 modules



P1 MB... 2P...

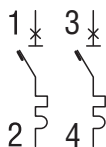

Order code	Curve	IEC In	Rated voltage	N° of DIN mod.	Qty per pkg	Wt
		[A]	[V]	n°	n°	[kg]

Two pole, thermal and magnetic trip type, C-curve characteristic.

P1 MB UH 2P C01	C	1	480Y/277	2	6	0.255
P1 MB UH 2P C01V6	C	1.6	480Y/277	2	6	0.255
P1 MB UH 2P C02	C	2	480Y/277	2	6	0.255
P1 MB UH 2P C03	C	3	480Y/277	2	6	0.255
P1 MB UH 2P C04	C	4	480Y/277	2	6	0.255
P1 MB UH 2P C05	C	5	480Y/277	2	6	0.255
P1 MB UH 2P C06	C	6	480Y/277	2	6	0.255
P1 MB UH 2P C07	C	7	480Y/277	2	6	0.255
P1 MB UH 2P C08	C	8	480Y/277	2	6	0.255
P1 MB UH 2P C10	C	10	480Y/277	2	6	0.255
P1 MB UH 2P C12	C	12	480Y/277	2	6	0.255
P1 MB UH 2P C13	C	13	480Y/277	2	6	0.255
P1 MB UH 2P C15	C	15	480Y/277	2	6	0.255
P1 MB UH 2P C16	C	16	480Y/277	2	6	0.255
P1 MB UH 2P C20	C	20	480Y/277	2	6	0.255
P1 MB UH 2P C25	C	25	480Y/277	2	6	0.255
P1 MB UH 2P C30	C	30	480Y/277	2	6	0.255
P1 MB UH 2P C32	C	32	480Y/277	2	6	0.255
P1 MB UL 2P C35	C	35	240	2	6	0.255
P1 MB UL 2P C40	C	40	240	2	6	0.255
P1 MB UL 2P C50	C	50	240	2	6	0.255
P1 MB UL 2P C60	C	60	240	2	6	0.255
P1 MB UL 2P C63	C	63	240	2	6	0.255

Two pole, thermal and magnetic trip type, D-curve characteristic.

P1 MB UH 2P D01	D	1	480Y/277	2	6	0.255
P1 MB UH 2P D01V6	D	1.6	480Y/277	2	6	0.255
P1 MB UH 2P D02	D	2	480Y/277	2	6	0.255
P1 MB UH 2P D03	D	3	480Y/277	2	6	0.255
P1 MB UH 2P D04	D	4	480Y/277	2	6	0.255
P1 MB UH 2P D05	D	5	480Y/277	2	6	0.255
P1 MB UH 2P D06	D	6	480Y/277	2	6	0.255
P1 MB UH 2P D07	D	7	480Y/277	2	6	0.255
P1 MB UH 2P D08	D	8	480Y/277	2	6	0.255
P1 MB UH 2P D10	D	10	480Y/277	2	6	0.255
P1 MB UH 2P D12	D	12	480Y/277	2	6	0.255
P1 MB UH 2P D13	D	13	480Y/277	2	6	0.255
P1 MB UH 2P D15	D	15	480Y/277	2	6	0.255
P1 MB UH 2P D16	D	16	480Y/277	2	6	0.255
P1 MB UH 2P D20	D	20	480Y/277	2	6	0.255
P1 MB UH 2P D25	D	25	480Y/277	2	6	0.255
P1 MB UH 2P D30	D	30	480Y/277	2	6	0.255
P1 MB UH 2P D32	D	32	480Y/277	2	6	0.255
P1 MB UL 2P D35	D	35	240	2	6	0.255
P1 MB UL 2P D40	D	40	240	2	6	0.255
P1 MB UL 2P D50	D	50	240	2	6	0.255
P1 MB UL 2P D60	D	60	240	2	6	0.255
P1 MB UL 2P D63	D	63	240	2	6	0.255

### General characteristics

These devices comply with the UL 489 standard, mostly used in the North American markets, are designed to protect feeder circuits, the part of the system from the network supply point to the protection device for a branch circuit. They can in any case be used on the international market thanks to compliance with the IEC/EN60947-2 standard as well.

They have characteristics of tripping instantaneously defined as follows:

- C-curve: instantaneous trip 5...10 times  $I_n$  for inductive loads (mixed loads, resistive and inductive with low inrush current)
- D-curve: instantaneous trip 10...14 times  $I_n$  for highly inductive loads (loads with high inrush and current such as motors).

### Operational characteristics

- Rated voltage 1...32A: 480Y/277V (UL489)
- Rated voltage 35...63A: 240V (UL489)
- Rated insulation voltage  $U_i$ : 440V (IEC/EN60947-2)
- Rated impulse voltage  $U_{imp}$ : 4kV (IEC/EN60947-2)
- Rated operational voltage  $U_e$ : 230/400VAC (IEC/EN60947-2)
- DC operational voltage: 125V

### Certifications and compliance

Certifications obtained: EAC, cULus (E471594).  
Compliant with standards: UL 489, IEC/EN 60947-2.

### 3P - 10kA 3 modules



P1 MB... 3P...

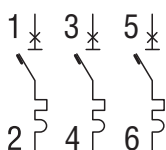

Order code	Curve	IEC In	Rated voltage	N° of DIN mod.	Qty per pkg	Wt
		[A]	[V]	n°	n°	[kg]

Three pole, thermal and magnetic trip type, C-curve characteristic.

P1 MB UH 3P C01	C	1	480Y/277	3	4	0.388
P1 MB UH 3P C01V6	C	1.6	480Y/277	3	4	0.388
P1 MB UH 3P C02	C	2	480Y/277	3	4	0.388
P1 MB UH 3P C03	C	3	480Y/277	3	4	0.388
P1 MB UH 3P C04	C	4	480Y/277	3	4	0.388
P1 MB UH 3P C05	C	5	480Y/277	3	4	0.388
P1 MB UH 3P C06	C	6	480Y/277	3	4	0.388
P1 MB UH 3P C07	C	7	480Y/277	3	4	0.388
P1 MB UH 3P C08	C	8	480Y/277	3	4	0.388
P1 MB UH 3P C10	C	10	480Y/277	3	4	0.388
P1 MB UH 3P C12	C	12	480Y/277	3	4	0.388
P1 MB UH 3P C13	C	13	480Y/277	3	4	0.388
P1 MB UH 3P C15	C	15	480Y/277	3	4	0.388
P1 MB UH 3P C16	C	16	480Y/277	3	4	0.388
P1 MB UH 3P C20	C	20	480Y/277	3	4	0.388
P1 MB UH 3P C25	C	25	480Y/277	3	4	0.388
P1 MB UH 3P C30	C	30	480Y/277	3	4	0.388
P1 MB UH 3P C32	C	32	480Y/277	3	4	0.388
P1 MB UL 3P C35	C	35	240	3	4	0.388
P1 MB UL 3P C40	C	40	240	3	4	0.388
P1 MB UL 3P C50	C	50	240	3	4	0.388
P1 MB UL 3P C60	C	60	240	3	4	0.388
P1 MB UL 3P C63	C	63	240	3	4	0.388

Three pole, thermal and magnetic trip type, D-curve characteristic.

P1 MB UH 3P D01	D	1	480Y/277	3	4	0.388
P1 MB UH 3P D01V6	D	1.6	480Y/277	3	4	0.388
P1 MB UH 3P D02	D	2	480Y/277	3	4	0.388
P1 MB UH 3P D03	D	3	480Y/277	3	4	0.388
P1 MB UH 3P D04	D	4	480Y/277	3	4	0.388
P1 MB UH 3P D05	D	5	480Y/277	3	4	0.388
P1 MB UH 3P D06	D	6	480Y/277	3	4	0.388
P1 MB UH 3P D07	D	7	480Y/277	3	4	0.388
P1 MB UH 3P D08	D	8	480Y/277	3	4	0.388
P1 MB UH 3P D10	D	10	480Y/277	3	4	0.388
P1 MB UH 3P D12	D	12	480Y/277	3	4	0.388
P1 MB UH 3P D13	D	13	480Y/277	3	4	0.388
P1 MB UH 3P D15	D	15	480Y/277	3	4	0.388
P1 MB UH 3P D16	D	16	480Y/277	3	4	0.388
P1 MB UH 3P D20	D	20	480Y/277	3	4	0.388
P1 MB UH 3P D25	D	25	480Y/277	3	4	0.388
P1 MB UH 3P D30	D	30	480Y/277	3	4	0.388
P1 MB UH 3P D32	D	32	480Y/277	3	4	0.388
P1 MB UL 3P D35	D	35	240	3	4	0.388
P1 MB UL 3P D40	D	40	240	3	4	0.388
P1 MB UL 3P D50	D	50	240	3	4	0.388
P1 MB UL 3P D60	D	60	240	3	4	0.388
P1 MB UL 3P D63	D	63	240	3	4	0.388

#### General characteristics

These devices comply with the UL 489 standard, mostly used in the North American markets, are designed to protect feeder circuits, the part of the system from the network supply point to the protection device for a branch circuit. They can in any case be used on the international market thanks to compliance with the IEC/EN60947-2 standard as well.

They have characteristics of tripping instantaneously defined as follows:

- C-curve: instantaneous trip 5...10 times In for inductive loads (mixed loads, resistive and inductive with low inrush current)
- D-curve: instantaneous trip 10...14 times In for highly inductive loads (loads with high inrush and current such as motors).

#### Operational characteristics

- Rated voltage 1...32A: 480Y/277V (UL 489)
- Rated voltage 35...63A: 240V (UL 489)
- Rated insulation voltage Ui: 440V (IEC/EN60947-2)
- Rated impulse voltage Uimp: 4kV (IEC/EN60947-2)
- Rated operational voltage Ue: 230/400VAC (IEC/EN60947-2)
- DC operational voltage: 125V

#### Certifications and compliance

Certifications obtained: EAC, cULus (E471594).  
Compliant with standards: UL 489, IEC/EN 60947-2.

### 1P, 2P, 3P and 4P - 10kA



P2 MB 1P...



P2 MB 2P...

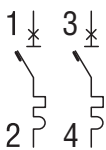

P2 MB 3P...

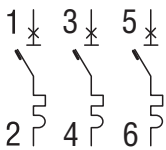

P2 MB 4P...

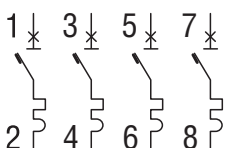

Order code	Curve	IEC In	IEC Icn	N° of DIN module	Qty per pkg	Wt
		[A]	[kA]	no.	no.	[kg]

One pole, thermal and magnetic trip type, C-curve characteristic.

P2 MB 1P C080	C	80	10 <sup>Ⓢ</sup>	1.5	9	0.166
P2 MB 1P C100	C	100	10 <sup>Ⓢ</sup>	1.5	9	0.166
P2 MB 1P C125	C	125	10 <sup>Ⓢ</sup>	1.5	9	0.166

Two pole, thermal and magnetic trip type, C-curve characteristic.

P2 MB 2P C080	C	80	10	3	4	0.340
P2 MB 2P C100	C	100	10	3	4	0.340
P2 MB 2P C125	C	125	10	3	4	0.340

Three pole, thermal and magnetic trip type, C-curve characteristic.

P2 MB 3P C080	C	80	10	4.5	3	0.510
P2 MB 3P C100	C	100	10	4.5	3	0.510
P2 MB 3P C125	C	125	10	4.5	3	0.510

Four pole, thermal and magnetic trip type, C-curve characteristic.

P2 MB 4P C080	C	80	10	6	2	0.680
P2 MB 4P C100	C	100	10	6	2	0.680
P2 MB 4P C125	C	125	10	6	2	0.680

Three pole, thermal and magnetic trip type, D-curve characteristic.

P2 MB 3P D080	D	80	10	4.5	3	0.510
P2 MB 3P D100	D	100	10	4.5	3	0.510
P2 MB 3P D125	D	125	10	4.5	3	0.510

Four pole, thermal and magnetic trip type, D-curve characteristic.

P2 MB 4P D080	D	80	10	6	2	0.510
P2 MB 4P D100	D	100	10	6	2	0.510
P2 MB 4P D125	D	125	10	6	2	0.510

<sup>Ⓢ</sup> Icn at 230V.

#### General characteristics

These devices are used to protect against short circuits and overloads of wiring installations and loads in panel boards, office buildings, stores and similar applications.

Their purpose is circuit protection, circuit isolation and load operation controls. They have characteristics of instantaneous trip defined as follows:

- C-curve: instantaneous trip 5...10 times In for inductive loads (mixed loads, resistive and inductive with low inrush current)
- D-curve: instantaneous trip 10...14 times In for highly inductive loads (loads with high inrush and current such as motors).

Main features include:

- IEC rated current In: 80...125A
- Pole width: 27mm / 1.06"
- Contact status with flag indicator
- Trip characteristic: Curve type C and D
- Fixing on 35mm DIN rail (IEC/EN 60715).

#### Operational characteristics

- Dissipation per pole: 15...20W
- IEC rated insulation voltage Ui: 400V
- IEC rated impulse voltage Uimp: 6kV
- IEC rated operational voltage Ue: 230/400VAC.

#### UL rating

Rated voltage: 240VAC - 5kA (1 pole)  
Rated voltage: 480VAC - 5kA (2-3-4 poles).

#### Certifications and compliance

Certifications obtained: EAC, TÜV – Rheinland; UL Recognized for USA and Canada (cURus – File E359585) as "Supplementary Protectors", designated as Overcurrent type, for general industrial use, suitable for factory wiring only with more than 135% tripping current of amp rating. Products having this type of marking are intended for use as components of complete workshop- assembled equipment. Compliant with standards: IEC/EN 60898-1, IEC/EN 60947-2, UL 1077, CSA C22.2 n°235.

### Add-on blocks for miniature circuit breakers 1...63A



P1X 1011

P1X 16230

Order code	Description	Qty per MCB	Qty per pkg	Wt
		n°	n°	[kg]
Auxiliary contact.				
<b>P1X 1011</b>	1 changeover contact	1	10	0.040
<b>P1X 1011UH</b>	1 changeover contact for P1 MB U	1	10	0.040
Indicator contact for thermal-magnetic trip.				
<b>P1X 1311</b>	1 changeover contact	1	10	0.040
Undervoltage trip release.				
<b>P1X 14230</b>	230V 50/60Hz	1	8	0.070
Shunt trip release.				
<b>P1X 16230</b>	110...415V 50/60Hz	1	8	0.070

ⓘ Not suitable for P1 MB U...

#### General characteristics

- Auxiliary and indicator contact width: 9mm/0.35" (0.5 module)
- Undervoltage and shunt trip release width: 18mm/0.71" (1 module)
- Maximum combination: 3 add-on blocks on MCB left side of which 1 undervoltage or shunt release directly on MCB side and then 2 contacts of which 1 auxiliary and 1 indicator.

#### Operational characteristics

- IEC rated impulse voltage Uimp: 4kV
- IEC rated operational current in AC: 6A 230V; 3A 400V (auxiliary contacts).

#### Certifications and compliance

Certifications obtained: EAC, cURus (excluding P1X 14230), UL (only P1X 14230)  
Compliant with standards: IEC/EN 60947-5-1, CSA C22.2 n° 5.

### Add-on blocks for miniature circuit breakers 80...125A



P2X 1311

P2X 16230

Order code	Description	Qty per MCB	Qty per pkg	Wt
		n°	n°	[kg]
Auxiliary contact.				
<b>P2X 1011</b>	1 changeover contact	1	10	0.040
Indicator contact for thermal-magnetic trip.				
<b>P2X 1311</b>	1 changeover contact	1	10	0.040
Shunt trip release.				
<b>P2X 16230</b>	110...415V 50/60Hz	1	8	0.070

#### General characteristics

- Auxiliary and indicator contact width: 9mm/0.35" (0.5 module)
- Shunt trip release width: 17.5mm/0.69" (1 module)
- Maximum combination: 3 add-on blocks on MCB sides of which 1 undervoltage or shunt release on MCB right side and 2 contacts on the left of which 1 auxiliary and 1 indicator.

#### Operational characteristics

- Rated impulse voltage Uimp: 4kV
- Rated operational current in AC: 6A 230V; 3A 400V (auxiliary contacts).

#### Certifications and compliance

Certifications obtained: EAC.  
Compliant with standards: IEC/EN 60947-5-1.

### Modular socket



P1X7

Order code	Description	Qty per pkg	Wt
		n°	[kg]
<b>P1X7</b>	Modular socket Italian and German (Schuko) standard; 16A.	5	0.123

#### General and operational characteristics

- Max. current: 16A
- Connectable section 1.5...10mm<sup>2</sup>
- Tightening torque: 1.8Nm
- Fixing on 35mm DIN rail (IEC/EN 60715)
- DIN modules: 2.5.

#### Certifications and compliance

Certifications obtained: EAC.  
Compliant with standards: IEC 60884-1.

### Accessories for miniature circuit breakers



P1X 90 33



P1X 91 33



P1X 92 01

P1X 92 10

P1X 92 02



P1X 18 10

P2X 18 10

① Suitable for P1 MB...  
Not suitable for P1 MB U...

Order code	Description	Qty per pkg	Wt
		n°	[kg]
P1X 90 31①	Single-pole supply busbar	10	0.160
P1X 90 32①	Two-pole supply busbar	10	0.320
P1X 90 33①	Three-pole supply busbar	10	0.474
P1X 90 34①	Four-pole supply busbar	10	0.600
P1X 90 90	Supply busbar P1RC4P +8 P1MB1MB	10	0.158
P1X 91 30①	Kit of 5 isolating covers for unused busbar terminals	10	0.030
P1X 91 31①	End cap for P1X9031	50	0.001
P1X 91 32①	End cap for P1X9032	50	0.001
P1X 91 33①	End cap for P1X9033	50	0.001
P1X 91 34①	End cap for P1X9034	50	0.001
P1X 92 01①	Single-pole terminal for busbar supply; conductor cross section 25mm <sup>2</sup> max.	25	0.010
P1X 92 10①	1-pole terminal for supplying busbar; conductor cross section 25mm <sup>2</sup> max.; left entry	25	0.010
P1X 92 02①	Single-pole terminal for busbar supply; conductor cross section 50mm <sup>2</sup> max.	25	0.022
P1X 18 10	Padlockable attachment for breaker control lever P1MB...	10	0.001
P2X 18 10	Padlockable attachment for breaker control lever P2MB...	10	0.002

### General and operational characteristics

#### SINGLE-POLE SUPPLY BUSBAR

- Rated operational voltage Ue: 1000V
- Central point of power supply: 100A max.
- Side point of power supply: 63A max.
- Spacing: 17.5mm/0.69"
- Busbar section: 10mm<sup>2</sup>
- For paralleling connection
- For 57 modules, 1000mm/39.37" long (57 1P breakers).

#### TWO-POLE, THREE-POLE AND FOUR-POLE SUPPLY BUSBARS

- Rated operational voltage Ue: 690V
- Central point of power supply: 100A max.
- Side point of power supply: 63A max.
- Pitch: 18mm/0.71"
- Busbar section: 10mm<sup>2</sup>
- For paralleling connection
- Two-pole: for 56 modules, 1000mm/39.37" long (28 2P breakers)
- Three-pole: for 57 modules, 1012mm/39.84" long (19 3P breakers)
- Four-pole: for 56 modules, 1000mm/39.37" long (14 4P breakers).

#### PADLOCKABLE ATTACHMENT

- Max. padlock diameter 5mm/0.20"
- Padlockable in ON and OFF
- One can be fitted for each pole of the breaker.

### UL approved supply busbar



ULC...



BRU3V



802094

**new**

Order code	Description	Qty per pkg	Wt
		n°	[kg]
Power bars for UL1077 thermal-magnetic circuit breakers, type P1 MB...			
1P18K57S0U50	Single-pole supply busbar	10	0.160
2P18L56S0U50	Two-pole supply busbar	10	0.320
3P18L57S0U50	Three-pole supply busbar	10	0.474
BRB5W	Kit of 5 insulating caps for unused bar terminals	10	0.030
A69	End cap for 1P18K57S0U50	50	0.001
A7	End cap for 2P18L56S0U50 and 3P18L57S0U50	50	0.001
802150S	Single-pole terminal block to supply busbar 1P18K57S0U50; conductor section 10 to 1 AWG	25	0.030
802180	Single-pole terminal block to supply busbar 2P18L56S0U50 and 3P18L57S0U50; conductor section 10 to 1 AWG	10	0.030
Power bars for UL489 thermal-magnetic circuit breakers, type P1 MB U...			
ULC157A18A	Single pole power bar	10	0.160
ULC256A18A	Two pole power bar	10	0.320
ULC357A18A	Three pole power bar	10	0.474
BRU3V	Kit of 3 insulating caps for unused bar terminals	10	0.022
A68	End cap for all ULC... type bars	50	0.001
802307	Single-pole terminal block to power bars; conductor section 14 to 2 AWG	10	0.030

### Main features

UL approved power bars are divided into two groups:

- bars for UL1077 approved thermal-magnetic circuit breakers
- bars for UL489 approved thermal-magnetic circuit breaker bars.

Both models are supplied 1000 mm long and can be cut to the desired length. This feature makes it easy to adapt to any combination of installed thermal-magnetic circuit breakers. Special end caps must be applied at the points where the bars are cut, to ensure IP20 protection and to comply with UL standards.

### Operational characteristics

#### POWER BARS FOR UL APPROVED THERMAL-MAGNETIC CIRCUIT BREAKERS

- maximum rated AC voltage: 600V
- central power point: 160 A max
- side point for power supply: 80 A max
- pitch: 17.8 mm
- bar section: 18 mm<sup>2</sup>
- for parallel connection
- single pole: for 57 modules, 1000 mm long (57 1P switches)
- two pole: for 56 modules, 1000 mm long (28 2P switches)
- three pole: for 57 modules, 1012 mm long (19 3P switches).

### Certifications

UL508 for ... P18K57... bars (for use with UL1077 approved thermal-magnetic circuit breakers).

UL489 for UL... bars (for use with UL489 approved thermal-magnetic circuit breakers).

### Residual blocks



P1 RA 2P...



P1 RA 3P...

Order code	Type	IEC In	IEC IΔn	N° of DIN module	Qty per pkg	Wt
		[A]	[mA]	n°	n°	[kg]
Residual blocks – 2P – type A.						
<b>P1 RA 2P 40 A030</b>	A	40	30	2	1	0.160
<b>P1 RA 2P 40 A300</b>	A	40	300	2	1	0.160
<b>P1 RA 2P 63 A030</b>	A	63	30	2	1	0.160
<b>P1 RA 2P 63 A300</b>	A	63	300	2	1	0.160
Residual blocks – 3P – type A.						
<b>P1 RA 3P 40 A030</b>	A	40	30	3.5	1	0.205
<b>P1 RA 3P 40 A300</b>	A	40	300	3.5	1	0.205
<b>P1 RA 3P 63 A030</b>	A	63	30	3.5	1	0.205
<b>P1 RA 3P 63 A300</b>	A	63	300	3.5	1	0.205
Residual blocks – 4P – type A.						
<b>P1 RA 4P 40 A030</b>	A	40	30	3.5	1	0.230
<b>P1 RA 4P 40 A300</b>	A	40	300	3.5	1	0.230
<b>P1 RA 4P 63 A030</b>	A	63	30	3.5	1	0.230
<b>P1 RA 4P 63 A300</b>	A	63	300	3.5	1	0.230

#### General characteristics

These devices are intended for the protection of people against indirect contact (electric shock) and of installations against fire hazards due to a persistent earth/ground fault current.

They snap onto the P1MB series thermal-magnetic circuit breakers; this combination forms a single device to protect people, protect against fire and protect lines.

#### Operational characteristics

- IEC rated insulation voltage  $U_i$ : 400V
- IEC rated impulse voltage  $U_{imp}$ : 4kV
- IEC rated frequency: 50/60Hz
- IEC rated operational voltage  $U_e$ : 230/400V
- IEC rated residual current for tripping  $I_{\Delta n}$ : 30mA; 300mA.

#### Certifications and compliance

Compliance with standards: IEC/EN 61009-1.  
 Certifications obtained: TUV-SUD, EAC.



### Residual current operated circuit breakers



P1 RC 2P...



P1 RC 4P...



P1 RC 4P B...

**new**

Order code	Type	IEC In	IEC IΔn	N° of DIN module	Qty per pkg	Wt
		[A]	[mA]	n°	n°	[kg]

Two pole RCCB type AC.

P1 RC 2P 25 AC030	AC	25	30	2	1	0.185
P1 RC 2P 25 AC300	AC	25	300	2	1	0.185
P1 RC 2P 40 AC030	AC	40	30	2	1	0.185
P1 RC 2P 40 AC300	AC	40	300	2	1	0.185
P1 RC 2P 63 AC030	AC	63	30	2	1	0.185
P1 RC 2P 63 AC300	AC	63	300	2	1	0.185

Two pole RCCB type A.

P1 RC 2P 25 A030	A	25	30	2	1	0.185
P1 RC 2P 25 A300	A	25	300	2	1	0.185
P1 RC 2P 40 A030	A	40	30	2	1	0.185
P1 RC 2P 40 A300	A	40	300	2	1	0.185
P1 RC 2P 63 A030	A	63	30	2	1	0.185
P1 RC 2P 63 A300	A	63	300	2	1	0.185

Four pole RCCB type AC.

P1 RC 4P 25 AC030	AC	25	30	4	1	0.326
P1 RC 4P 25 AC300	AC	25	300	4	1	0.326
P1 RC 4P 40 AC030	AC	40	30	4	1	0.326
P1 RC 4P 40 AC300	AC	40	300	4	1	0.326
P1 RC 4P 63 AC030	AC	63	30	4	1	0.326
P1 RC 4P 63 AC300	AC	63	300	4	1	0.326

Four pole RCCB type A.

P1 RC 4P 25 A030	A	25	30	4	1	0.326
P1 RC 4P 25 A300	A	25	300	4	1	0.326
P1 RC 4P 40 A030	A	40	30	4	1	0.326
P1 RC 4P 40 A300	A	40	300	4	1	0.326
P1 RC 4P 63 A030	A	63	30	4	1	0.326
P1 RC 4P 63 A300	A	63	300	4	1	0.326

Four pole RCCB type B.

P1 RC 4P 40 B030	B	40	30	4	1	0.335
P1 RC 4P 40 B300	B	40	300	4	1	0.335
P1 RC 4P 63 B030	B	63	30	4	1	0.335
P1 RC 4P 63 B300	B	63	300	4	1	0.335
P1 RC 4P 80 B030	B	80	30	4	1	0.335
P1 RC 4P 80 B300	B	80	300	4	1	0.335

### General characteristics

These RCCBs are intended for the protection of people against indirect contact (electric shock) and of installations against fire hazards due to a persistent earth/ground fault current. Specifically to prevent electric shock, RCCBs must be rated with a rated residual current (IΔn) not exceeding 30mA so that these devices trip in the case of earth/ground fault only. They usually are connected in series with thermal-magnetic breakers which assure short circuit and overcurrent protection too. P1RC types have a IΔn of either 30mA or 300mA and are available with three different versions of residual current tripping, as follows:

Type AC – Tripping for earth/ground fault is ensured “for residual sinusoidal alternating currents, suddenly applied or slowly rising”. It is identified by the symbol:

Type A – Tripping for earth/ground fault is ensured “for residual sinusoidal alternating currents and pulsating direct currents, suddenly applied or slowly rising”. In addition to the protection given by Type AC, this version protects against residual current with pulsating waveform. This can be caused by circuits connected with electronic equipment. The symbol identifying Type A is the following:

Type B – tripping is ensured for all conditions already covered by types AC and A. They also ensure tripping for high-frequency leakage currents up to 1000Hz and direct currents. They are particularly suitable for applications with inverters, UPSs and electric vehicle charging stations. The symbol identifying Type B is the following:

Main features include:

- IEC rated current In: 25A, 40A and 63A
- Versions: 2P and 4P
- Type of operation: AC, A and B
- Pole width: 17.5mm / 0.69"
- Contact status with flag indicator
- Fixing on 35mm DIN rail (IEC/EN 60715).

### Operational characteristics

- Dissipation per pole:
  - 1.1W for P1RC2/4 P25... type AC or A
  - 2.9W for P1RC2/4 P40... type AC, A or B
  - 7.2W for P1RC2/4P63... type AC, A or B
  - 9.7W for P1RC/4P80... type B
- IEC rated insulation voltage Ui: 400V
- IEC rated impulse voltage Uimp: 4kV
- IEC rated frequency: 50/60Hz
- IEC rated operational voltage Uc: 230VAC for 2P; 230/400VAC for 4P
- IEC rated residual operating voltage Ue: IΔn: 30mA; 300mA
- IEC short-circuit breaking capacity Icn: 10kA

### Certifications and compliance

Certifications obtained: TÜV SÜD (types AC and A), EAC. Compliant with standards: IEC/EN 61008-1 (all types); IEC/EN 62423 (type B).

### 1P+N - 10kA 2 modules



P1 RB 1N...

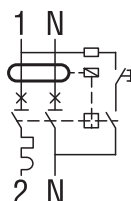

Order code	Curve	IEC In	IEC Icn	IEC IΔn	DIN	Qty per pkg	Wt
		[A]	[kA]	[mA]	n°	n°	[kg]

Single pole + neutral RCBO type AC.							
P1 RB 1N C06 AC030	C	6	10	30	2	1	0.205
P1 RB 1N C06 AC300	C	6	10	300	2	1	0.205
P1 RB 1N C10 AC030	C	10	10	30	2	1	0.205
P1 RB 1N C10 AC300	C	10	10	300	2	1	0.205
P1 RB 1N C16 AC030	C	16	10	30	2	1	0.205
P1 RB 1N C16 AC300	C	16	10	300	2	1	0.205
P1 RB 1N C20 AC030	C	20	10	30	2	1	0.205
P1 RB 1N C20 AC300	C	20	10	300	2	1	0.205
P1 RB 1N C25 AC030	C	25	10	30	2	1	0.205
P1 RB 1N C25 AC300	C	25	10	300	2	1	0.205
P1 RB 1N C32 AC030	C	32	10	30	2	1	0.205
P1 RB 1N C32 AC300	C	32	10	300	2	1	0.205
P1 RB 1N C40 AC030	C	40	10	30	2	1	0.205
P1 RB 1N C40 AC300	C	40	10	300	2	1	0.205
Single pole + neutral RCBO type A.							
P1 RB 1N C06 A030	C	6	10	30	2	1	0.205
P1 RB 1N C06 A300	C	6	10	300	2	1	0.205
P1 RB 1N C10 A030	C	10	10	30	2	1	0.205
P1 RB 1N C10 A300	C	10	10	300	2	1	0.205
P1 RB 1N C13 A030	C	13	10	30	2	1	0.205
P1 RB 1N C16 A030	C	16	10	30	2	1	0.205
P1 RB 1N C16 A300	C	16	10	300	2	1	0.205
P1 RB 1N C20 A030	C	20	10	30	2	1	0.205
P1 RB 1N C20 A300	C	20	10	300	2	1	0.205
P1 RB 1N C25 A030	C	25	10	30	2	1	0.205
P1 RB 1N C25 A300	C	25	10	300	2	1	0.205
P1 RB 1N C32 A030	C	32	10	30	2	1	0.205
P1 RB 1N C32 A300	C	32	10	300	2	1	0.205
P1 RB 1N C40 A030	C	40	10	30	2	1	0.205
P1 RB 1N C40 A300	C	40	10	300	2	1	0.205

### General characteristics

These devices both detect and trip in the event of residual current and protect circuits in the case of short circuits and overcurrent. From a practical point of view, they integrate both functions of MCB and of RCCB.

They have a C-type trip characteristic (instantaneous trip 5-10 times  $I_n$ ) and are used for inductive loads (mixed loads, resistive and inductive with low inrush current).

In addition, they have a rated residual current ( $I_{\Delta n}$ ) of either 30mA or 300mA and are available with two different versions of residual current tripping type AC or A as described on page 13-12.

Its main features are:

- IEC rated current  $I_n$ : 6...40A
- Version: 1P+N
- Contact status with flag indicator
- Trip characteristic: Curve type C
- Fixing on 35mm DIN rail (IEC/EN 60715).

### Operational characteristics

- Dissipation per pole: 3...13W
- Rated insulation voltage  $U_i$ : 400V
- Rated impulse voltage  $U_{imp}$ : 4kV
- Operating frequency: 50/60Hz
- Rated operational voltage  $U_e$ : 230VAC
- Rated residual operating voltage  $I_{\Delta n}$ : 30mA; 300mA
- IEC short-circuit breaking capacity  $I_{cn}$ : 10kA

### Certifications and compliance

Certifications obtained: TÜV Rheinland, EAC.  
Compliant with standards: IEC/EN 61009-1.

## MINIATURE CIRCUIT BREAKERS

**P1 MB...**

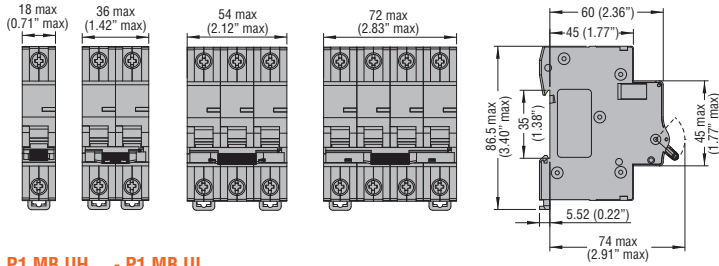

## ACCESSORIES

Add-on contacts

**P1X 1011 - P1X 1011 UH - P1X 1311**

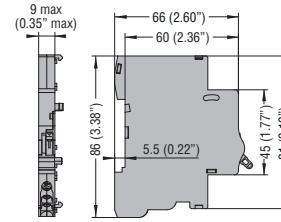

Undervoltage and shunt releases

**P1X 14230 - P1X 16230**

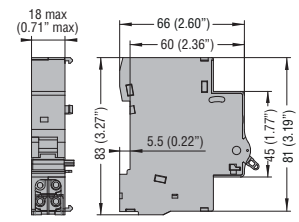

**P1 MB UH... - P1 MB UL....**

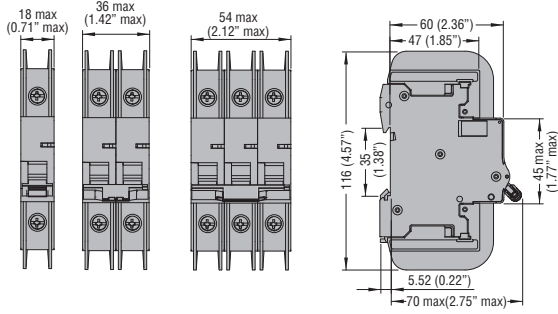

## MINIATURE CIRCUIT BREAKERS

**P2 MB...**

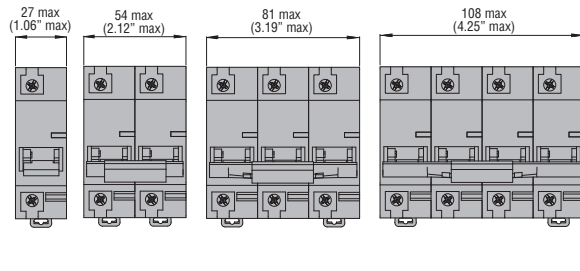

## ACCESSORIES

Add-on contacts

**P2X 1011 - P2X 1311**

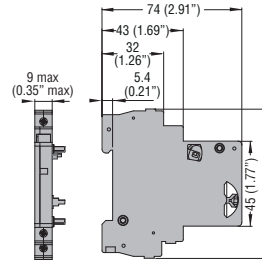

Shunt release

**P2X 16230**

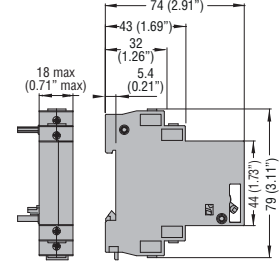

## RESIDUAL BLOCKS

**P1 RA**

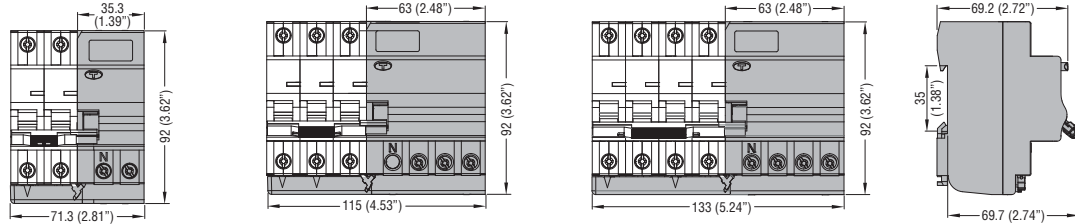

## RESIDUAL CURRENT OPERATED CIRCUIT BREAKERS

**P1 RC...**

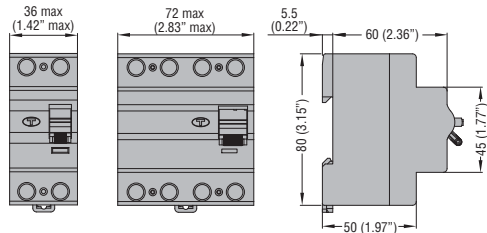

## RESIDUAL CURRENT OPERATED CIRCUIT BREAKERS WITH OVERCURRENT PROTECTION

**P1 RB...**

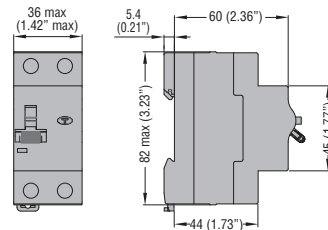

## MODULAR SOCKET

**P1X7**

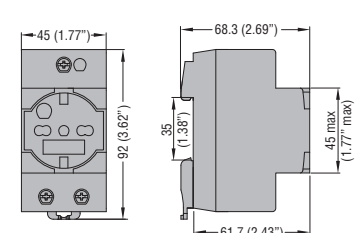

## Wiring diagrams

**P1X 1011 - P1X 1011UH - P2X 1011**

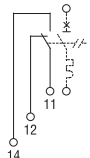

**P1X 1311 - P2X 1311**

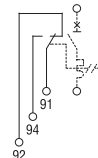

**P1X 14230**

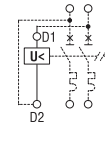

**P1X 16230 - P2X 16230**

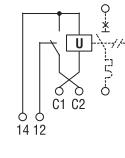

TYPE		P1 MB	P2 MB	P1 RA	P1 RC	P1 RB
Description		Circuit breaker	Circuit breaker	Residual blocks	Residual current operated circuit breakers	Residual current operated circuit breakers w/ overcurrent prot.
Standards		IEC/EN 60898, IEC/EN 60947-2 UL 1077 UL 489①	IEC/EN 60947-2 UL 1077	IEC/EN 61008-1	IEC/EN 61008-1	IEC/EN 61009-1
IEC rated insulation voltage $U_i$	V	440	400	400	400	400
IEC rated impulse withstand voltage $U_{imp}$	kV	4	6	4	4	4
IEC rated operational voltage $U_e$	in AC	V 230 (1P, 1P+N) / 230/400 (2P, 3P, 4P)②	230 (1P) / 230/400 (2P, 3P, 4P)	230/400V	230 (2P) / 230/400(4P)	230
	in DC	V 60 (1P) / 80 (2P)③	60	—	—	—
Rated frequency	Hz	50/60	50/60	50/60	50/60	50/60
Maximum rated current	A	63	125	63	63	40
Available rated current for types	A	1, 2, 4, 6, 10, 13, 16, 20, 25, 32, 40, 50, 63④	80, 100, 125	40, 63	25, 40, 63 (80A only type B)	6, 10, 16, 20, 25, 32, 40
Versions		1P, 1P+N, 2P, 3P, 4P	1P, 2P, 3P, 4P	2P, 3P, 4P	2P, 4P	1P+N
Tripping characteristic	curve	B-C-D	C-D	—	—	C
Instantaneous tripping		Curve B: 3...5I <sub>n</sub> Curve C: 5...10I <sub>n</sub> Curve D: 10...14I <sub>n</sub>	Curve C: 5...10I <sub>n</sub> Curve D: 10...14I <sub>n</sub>	—	—	Curve C: 5...10I <sub>n</sub>
Residual operation characteristic	type	—	—	A	AC, A, B	AC, A
Rated residual current $\Delta n$	mA	—	—	30, 300	30, 300	30, 300
Short circuit capacity	kA	10 (6kA 1P+N)	10	—	10 (Inc)	10
Mechanical life	cycle	20,000	10,000	20,000	20,000	20,000
Maximum tightening torque of terminals	Nm	2	3	2	2	2
	lbin	15	26	15	15	15
	Tool	Pz2	Pz2	Pz2	Pz2	Pz2
Conductor section min...max.	mm <sup>2</sup>	1...16	2.5...50	1...16	2.5...35	1...25
	AWG	14...6	14...1/0	14...6	14...2	16...3

### AMBIENT CONDITIONS

Temperature	Operating	°C	-35...+70	-35...+75	-25...+55	-25...+55	-25...+40
	Storage	°C	-40...+80	-40...+80	-35...+60	-35...+60	-35...+60
Max. altitude		m	2,000	2,000	2,000	2,000	2,000
Pollution degree			2	3	2	2	2
Mounting			35mm DIN rail (IEC/EN 60715)				

### TRIP CHARACTERISTICS

Curve B

Tripping time [s]

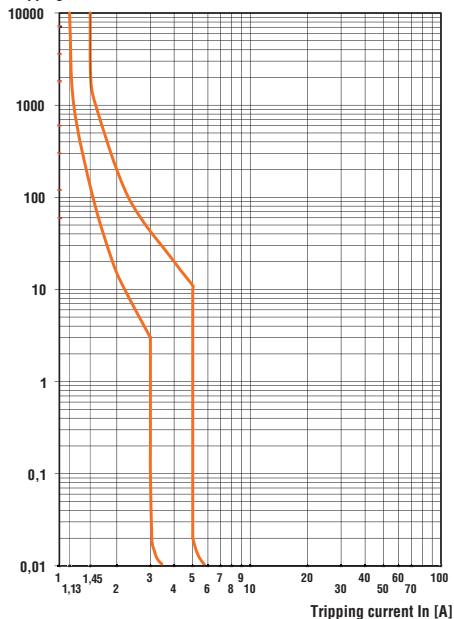

Curve C

Tripping time [s]

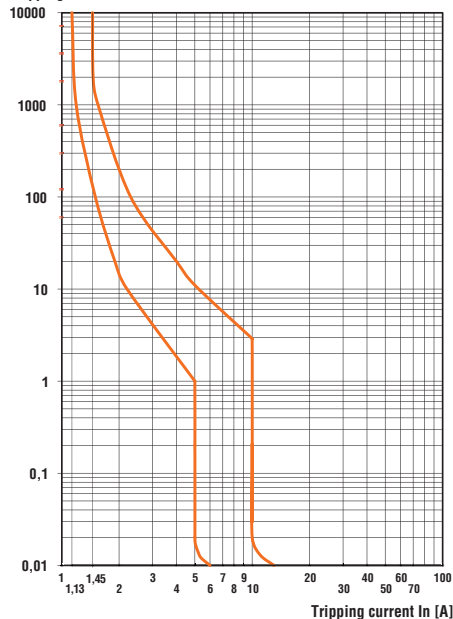

Curve D

Tripping time [s]

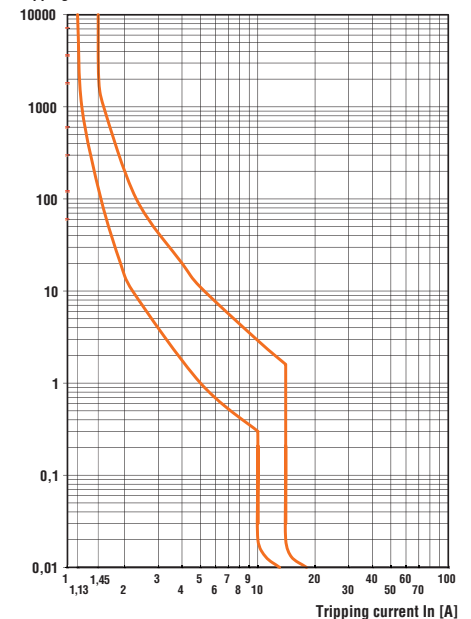

- ① UL489 only P1MBU... version for the operational voltages for these devices refer to the pages for the chosen product.
- ② For the UL489, P1MBU... versions, the following rated current currents are also available: 1.6, 3, 5, 7, 8, 12, 15, 30, 35, 60 A.
- ③ For the UL489, P1MBU... versions to 32A: 1P 277V; 2P and 3P 480Y/277V. From 35 to 63A: 1P 120V, 2P and 3P 240V.
- ④ For the UL489, P1MBU..., 1P 60VDC and 2P 125VDC.