

ID	Description	Date	By	Appr.
A				

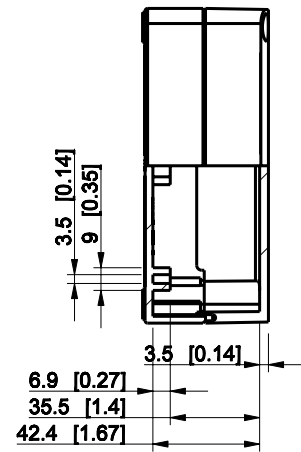
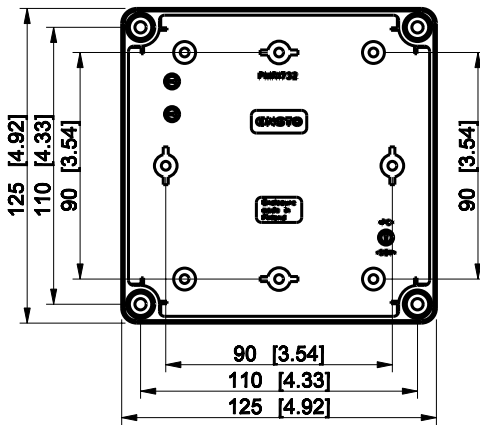
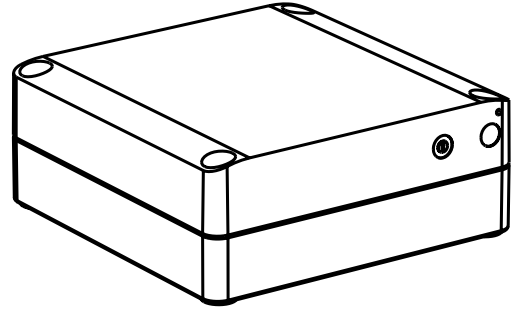
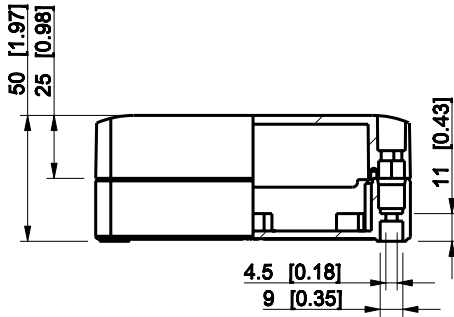

Dimensions in mm [inches]

Material: ABS	Color: RAL 7035
---------------	-----------------

Supplier:	Tool No:	Weight [kg]: 0.22	Volume:
-----------	----------	-------------------	---------



SABP131305LT

Scale	Date	04.12.08
1:3	By	PKos
-	Checked	
-	Ctrl	

Replaces:	
Replaced:	
Drw No:	- A
Ref:	Cubo S
Code:	SABP131305LT
Sheet No:	

model SABP131305LT .PART
drawing CUBOS_4.DRAWING